

ASANSÖRE DAİR ARADIĞINIZ, HER ŞEY...

EVERYTHING YOU ARE
LOOKING FOR ABOUT ELEVATORS...

2022
Ürün Kataloğu
Product Catalogue

MÜŞTERİ HİZMETLERİ
Customer Service
444 32 42

ONAYGROUP

Onaylift Components, bir onaygroup kuruluşudur.
Onaylift Components is an onaygroup organization.

ONAYLIFT[®]
COMPONENTS



onaylift.com.tr

CONTENTS

İçindekiler

ONAY KABİN®
ASANSÖR KABİNLERİ

ONAYLIFT®
COMPONENTS



01

Hakkımızda
About Us

03-04

04

Kumanda Panoları
Control Panels

78-83

02

Kabinler
Cabins

14-59

05

Makine Motor
Machine Motors

84-85

03

Otomatik Kapi
Automatic Door

62-77

06

Butonlar
Buttons

86-87



ONAY KUMANDA
KUMANDA SİSTEMLERİ

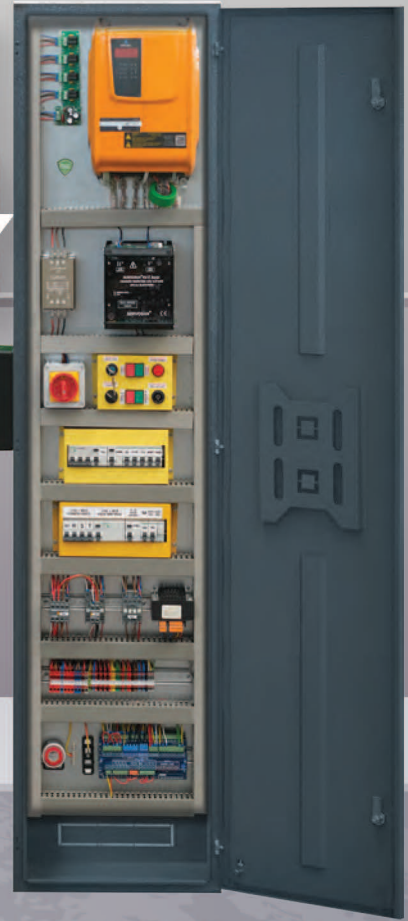



ASANSÖRE DAİR ARADIĞINIZ, HER ŞEY..

EVERYTHING ABOUT THE ELEVATOR
YOU ARE LOOKING FOR.

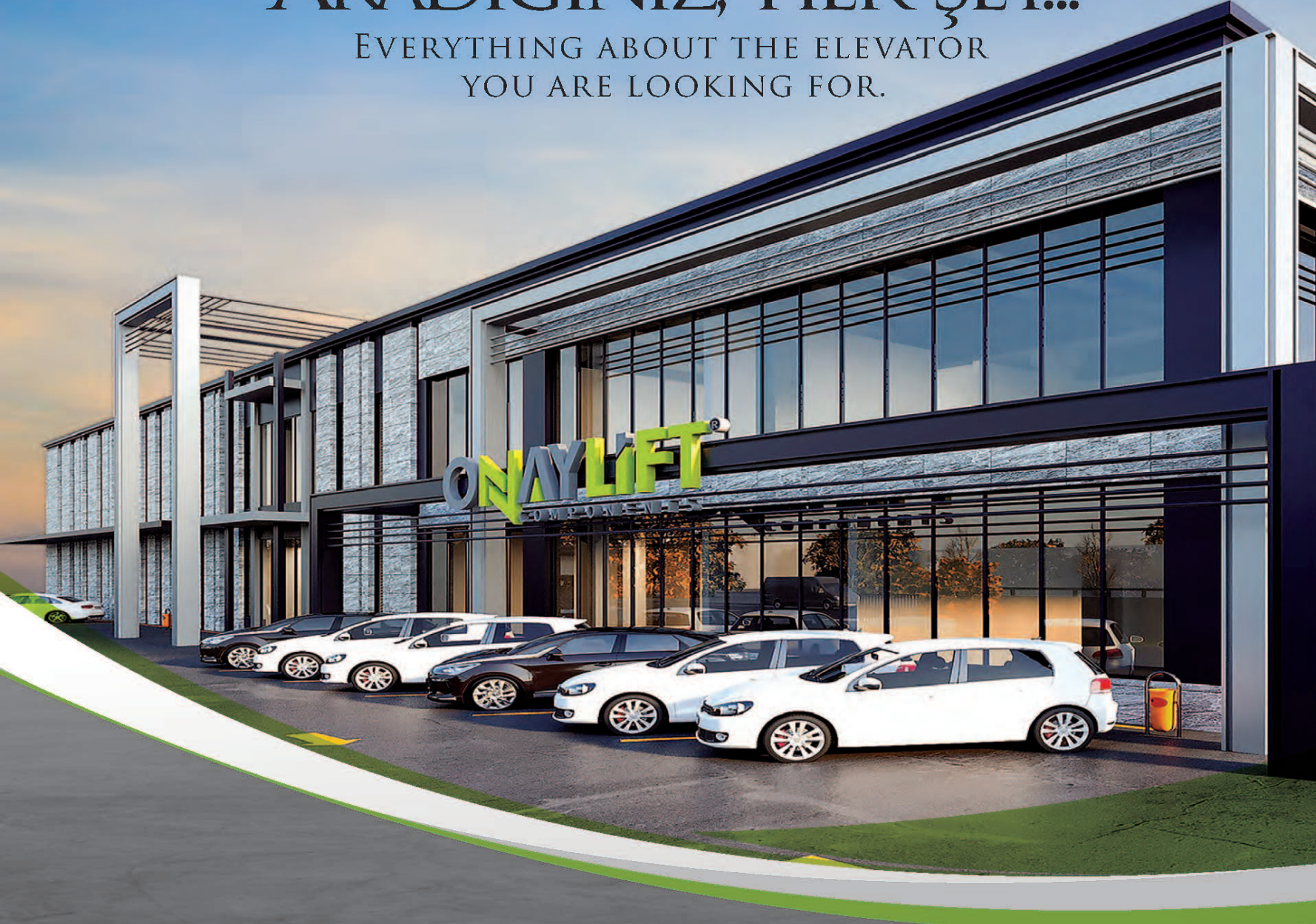

ONAY DOOR
KAPI SİSTEMLERİ

ONAY KABİN
ASANSÖR KABİNLERİ

ONAY KUMANDA
KUMANDA SİSTEMLERİ

MÜŞTERİ HİZMETLERİ
Customer Service
444 32 42

20.000
m²

Üretim Sahası

**5. Organize
Sanayi Bölgesi**

onaylift.com.tr



ONAY GROUP

Onaylift Components, bir onaygroup kuruluşudur.
Onaylift Components is an onaygroup organization.



Hakkımızda

Gerçekleşen teknolojik gelişmeler sebebi ile çoğalan rekabet ortamında öne çıkabilmek ancak kaliteli üretim ve teknoloji çağına uyum sağlayabilmek ile mümkündür. Hikayesi 2015 yılında başlayan Onaylift Asansör market, genç ve dinamik bir marka olmasının da avantajını kullanarak hedeflerini teknoloji çağına ayak uydurmak ve kaliteli üretim yapmak şeklinde belirlemiştir.

Sahip olduğu iş tecrübelerine ve bilgi birikimine güvenerek asansör sektörüne adım atan Mehmet İmamoğlu, Onaylift Asansör'ün ticaret serüvenini Konya Büsan Sanayi'nde başlatmıştır. Başarının temelinde kendini sürekli yenileyen teknolojik geliştirmeleri takip eden ve müşteri odaklı bir anlayış olduğuna inanan Mehmet İmamoğlu, Onaylift Asansör'ün hizmet anlayışını da bu yönde belirleyerek asansör sektöründe başarılı bir yol izlemektedir.

Onaylift Asansör, ticaret serüveninin ilk yıllarında 1000 m²'lik bir alanda üretim yaparken gerçekleştirdiği projeler ve yatırımlar ile 6 aylık bir zaman dilimi içerisinde üretim alanının 4000 m²'si kapalı olmak üzere toplamda 5200 m²'lik bir alanda üretim yapmaya başlamıştır. Büyüme sürecine paralel olarak 2019 yılında 10.000 m² kapalı, 5000 m² açık, toplamda 15.000m² alana sahip yeni yerinde üretime devam etmiştir. Son olarak da 2022 yılından itibaren 20.000 m² kapalı üretim tesislerinde, hedeflerini gerçekleştirme yolunda 150 çalışanı ile yıllık 2500 adet asansör kabini, 25.000 asansör kapısı ve 2.000 asansör kumanda panosu üretimi gerçekleştirmektedir. Onaylift Asansör, 'Sıfır İş Kazası' politikası ile sadece müşterilerine değil çalışanlarına da büyük önem verdiğini kanıtlamıştır.

Onaylift Asansör kurulduktan çok kısa bir süre sonra yurtdışı pazarına da girmeyi başararak 3 kıtada 56'dan fazla ülkeye ihracat yapmaya başlamıştır. Avrupa coğrafyasından, Asya steplerine, Afrika'nın güneyinden, Arabistan yarımadasına kadar adını duyurmuştur. İhracat sahasını genişleterek başarısını kanıtlayan Onaylift Asansör, ürün portföyünü de genişleterek aynı başarıyı sağlamıştır.

Onaylift Asansör'ün üretim portföyü temelde insan, servis, araç, engelli, yük, hastane ve monşarj asansörleri, asansör kapıları ve kumanda panolarından oluşmaktadır. Bunların yanında asansör motoru, asansör butonu, yerli yabancı asansör bileşenleri gibi ürünlerin de satışını yapmaktadır. Ürünlerin ve üretimin kalitesi, ISO 9001, TSE, CE ve asansör kapısı için EN 81-20 CE, yanmazlık belgesi ve EAC ile tescillenmiştir.

Onaylift Asansör'ün üretim tesisi; tasarım, lazer kesim, abkant büküm, kaynak, montaj, boyahane ve test alt birimlerinden oluşmaktadır. Üretim aşamasında bünyesinde barındırdığı tecrübeli mühendisler ve son teknoloji ürünü mekanizasyon sayesinde müşterilerin ihtiyaçlarına hitap eden bir marka konumuna gelmiştir. Firma bünyesinde bulunan tüm departmanların bütünleşik bir şekilde çalışması ERP kurumsal kaynak yönetim sistemi ile sağlanmaktadır. Kurulduğu günden bugüne hedeflerini gerçekleştirmek için çabalayan Onaylift Asansör Dünya çapında bir marka olmak için çalışmalarına devam etmektedir.

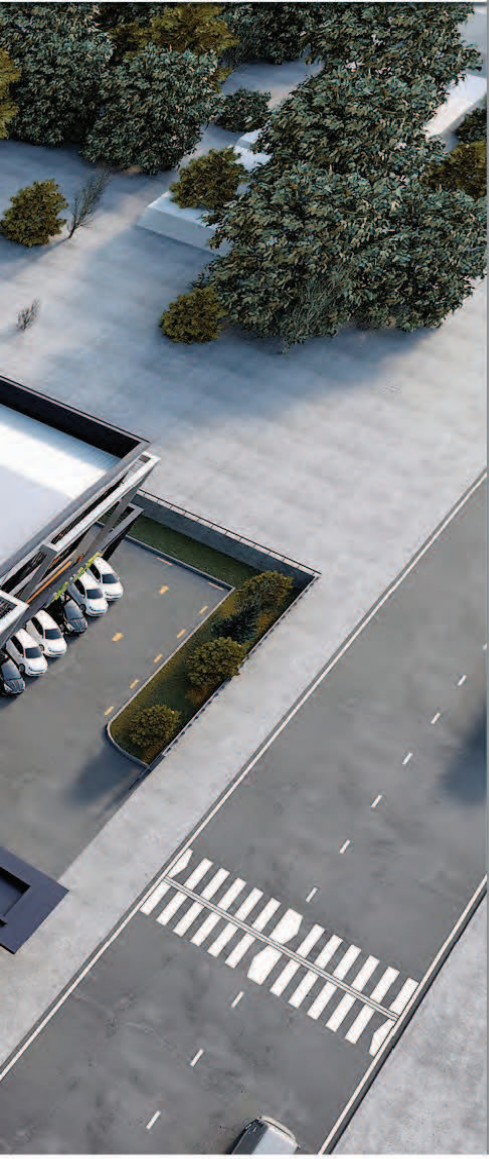

İsteyen herkese
ONAYLIFT veriyoruz...
We give ONAYLIFT to
everyone who wants...

ONAY DOOR®
KAPI SİSTEMLERİ

ONAY KABİN®
ASANSÖR KABİNLERİ

ONAY KUMANDA®
KUMANDA SİSTEMLERİ

About Us

It is only possible to stand out in the increasing competitive environment due to the technological developments that have taken place, only by adapting to the age of quality production and technology. With the advantage of being a young and dynamic brand, Onaylift Elevator Market, whose story started in 2015, has determined its goals as keeping up with the technology age and making quality production.

Mehmet İmamoğlu, who stepped into the elevator industry by relying on his work experience and knowledge, started the trade adventure of Onaylift Elevator in Konya Büsan Industry. Mehmet İmamoğlu, who believes that the basis of success is a customer-oriented approach and follows the technological developments that constantly renew itself, determines the service concept of Onaylift Elevator in this direction and follows a successful path in the elevator industry.

In the first years of its trade adventure, Onaylift Elevator started to produce in a total area of 5200 m², 4000 m² of which is closed, within a period of 6 months, with the projects and investments it realized while producing in an area of 1000 m². Parallel to the growth process, it continued production in its new location with a total area of 15.000 m², 10.000 m² closed and 5000 m² open area. Finally, since 2022, it has been producing 2500 elevator cabins, 25.000 elevator doors and 2.000 elevator control panels annually with its 150 employees on the way to realize its targets in 20.000 m² closed production facilities. Onaylift Elevator has proven that it attaches great importance not only to its customers but also to its employees with its 'Zero Occupational Accident' policy.

Very soon after its establishment, Onaylift Elevator was able to enter the foreign market and started exporting to more than 56 countries on 3 continents. Its name became famous from European geography to the Asian steppes, from South Africa to the Arabian Peninsula. Proving its success by expanding its export area, Onaylift Elevator has achieved the same success by expanding its product range.

The production portfolio of Onaylift Elevator basically consists of human, service, vehicle, disabled, freight, hospital and cargo elevators, elevator doors and control panels. In addition to these, it also sells products such as elevator motor, elevator button, domestic and foreign elevator components. The quality of the products and production has been registered with ISO 9001, TSE, CE and EN 81-20 CE for the elevator door, non-flammability certificate and EAC.

The production facility of Onaylift Elevator; It consists of design, laser cutting, bending, welding, assembly, paint shop and test sub-units. Thanks to its experienced engineers and state-of-the-art mechanization during the production phase, it has become a brand that caters to the needs of its customers. The integrated operation of all departments within the company is ensured by the ERP corporate resource management system. Onaylift Elevator, which has been striving to achieve its goals since the day it was founded, continues its efforts to become a worldwide brand.



Yeşil ortamların sorunsuz uyumu Seamless harmony of green environments

- Bizim ezeli rakibimiz belirli bir girişim değil, teknolojinin kendisi olmakla birlikte daha sürdürülebilir ve daha güzel bir dünyaya azami derecede katkıda bulunma hedefi doğrultusunda daha yeşil bir çevre kazandırmaktır.

Our arch-rival is not a specific enterprise, but a technology that is greener, but with the goal of contributing to a more sustainable and more beautiful world.



- Enerji tasarruflu asansör teknolojisini kapsamlı bir şekilde entegre eder.
- Kalıcı mıknatıslı senkron ve dişlisiz çekiş makinesi
- Enerji geri bildirim teknolojisi
- LED aydınlatma sistemi
- Asansör kabiniinde otomatik aydınlatma sistemi
- Geri dönüşümlü ambalaj malzemeleri
- Integrates energy-efficient elevator technology extensively.
- Permanent magnet synchronous and gearless traction machine
- Energy feedback technology
- LED lighting system
- Automatic lighting system in elevator cabin
- Recycled packaging materials

Enerji tasarruflu asansör teknolojisi
Energy saving elevator technology





1 Kalıcı mıknatıslı senkron ve dişsiz çekiş makinesi

Permanent magnet synchronous and gearless traction machine

Geleneksel çekiş makinelerinin ağırlığın yarısı olan yeni nesil sabit mıknatıslı senkron çekişli makine küçük bir kütleye sahiptir. Kolay kurulum ile bakım gerektirmez. Enerji tasarrufu ve etkisi geleneksel olandan %40 daha fazladır.

The new generation permanent magnet synchronous traction machine with a weight of half the weight of conventional traction machines has a small mass. Easy installation and maintenance-free. The energy saving effect is 40% higher than the traditional one.



1 LED aydınlatma sistemi LED lighting system

LED aydınlatma kaynağı uzun servis ömrüne sahiptir. Güç tüketiminin yaklaşık %35'ini azaltabilir. Işık geçirgenliği, güçlü ateşe dayanıklılığı ile cam yünü tavan malzemesi ile eşleşir. Bütün alanı yumuşak, ve zarif ışık kaynağı ile kaplar.

The LED lighting source has a long service life. It can reduce approximately 35% of power consumption. Its light transmittance and strong fire resistance match the glass wool ceiling material. The whole area is covered with a soft, and elegant light source.

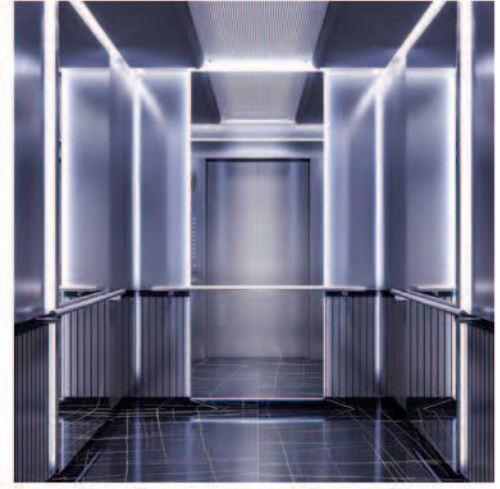

1 Asansör kabininde otomatik aydınlatma sistemi

Automatic lighting system in elevator cabin

Asansör uyku modundayken, kabin fanını ve aydınlatmayı otomatik olarak kapatır. Her ayrıntıda enerji ve güç tasarrufu sağlar. Asansör tarafından tüketilen gereksiz elektrik enerjisini önler.

When the elevator is in sleep mode, it automatically closes the cabin fan and lighting. Saves energy and power in every detail. Prevents unnecessary electrical energy consumed by the elevator.

1 Enerji geri bildirim teknolojisi Energy feedback technology

Enerji geri besleme teknolojisi DSP merkezi işlemci ve PWM (darbe genişlik modülasyonu) teknolojisini ile asansörde tam yükte aşağıya doğru hareket ve hafif yükte yukarı hareketinde, potansiyel enerjiyi elektrik enerjisine dönüştürür. Elektrik şebekesine ve diğer güç ekipmanlarına geri besler. Asansör enerji tüketiminin %30'undan fazlasını azaltabilir.

The energy feedback technology implements the DSP central processor and PWM (pulse width modulation) technology. It converts the potential energy into electrical energy in downward movement at full load and upward movement in light load. It feeds back to the power grid and other power equipment. The elevator can reduce more than 30% of the energy consumption.



Onaylift Asansör

Dünyaca ünlü Onaylift Asansör'ün ileri teknolojisi
Advanced technology of world famous Onaylift Elevator

Entelektüel mülkiyet gelecekteki asansörlerin gelişmekte olan trendi.

Intellectual property is the developing trend of future elevators.

- 1) VVVF değişken frekanslı kapı makine kontrol sistemi
VVVF variable frequency door machine control system



Kapı yükü dedektörü kendini ayarlama kapasitesine sahiptir. Asansör kapısı açma / kapama hassasiyetini artırır ve makul açma / kapama hızını sağlar. Çoklu koruma fonksiyonlarına sahiptir

The door load detector is capable of self-adjusting. The elevator door increases the opening / closing sensitivity and provides reasonable on / off speed. Features multiple protection functions

Çoklu koruma fonksiyonlu kapı sistemi
Multi-function door system

- Kapı algılama sensörü
• Door detection sensor
- Kabin kapısındaki algılama sensörü
• Sensing sensor in the cab door
- Kapama istemi sinyali ile ışık perdesi kapı sensörü
• Light curtain door sensor with shutdown prompt signal
- Çizgi dedektörü
• Line detector



1 Entegre kontrol sistemi
Integrated control system

Son nesil endüstriyel kontrol teknolojisi ve iletişim teknolojisi ile birleştirir. Uzaktan kumanda, doğrudan park, kapalı devre kontrol teknolojisi, CANBUS haberleşme teknolojisi, çoklu CPU teknolojisini kapsar. Entelektüel vektör tipi entegre kontrol sisteminin yeni neslini oluşturur.

Combines with the latest generation industrial control technology and communication technology. Includes remote control, direct parking, closed circuit control technology, CANBUS communication technology, multiple CPU technology. The intellectual vector type forms the next generation of the integrated control system.

1 Uzun mesafe monitör sistemi
Long Distance Monitor System

Uzun mesafeli monitör merkezinde asansörün içindeki koşullara telefon ağı erişimi, geniş bant internet erişimi, kablosuz internet erişimi vb. ile gerçek zamanlı olarak izleme yapar. Böylece yolcu güvenliği sağlanır.

In the center of the long-distance monitor, access to telephone network access, broadband internet access, wireless internet access and so on. Makes monitoring in real time with. This ensures passenger safety.

1 Grup denetim sistemi
Group supervision system

En yakın kurala göre entelektüel ve bilimsel gönderimi hızlı ve etkin bir şekilde yürütebilir. Yolcu bekleme süresini kısaltarak çalışma verimliliğini büyük ölçüde artırır.

According to the closest rule, it can conduct the intellectual and scientific dispatch quickly and effectively. It significantly increases the working efficiency by shortening passenger waiting time.

Onaylift Asansör

Makine daireli asansör Machine room elevator

Makine daireli asansörler ülkemizde ve dünyada en sık kullanılan sistemlerdir. Çalışma prensipleri temel olarak bir makine-motor mekanizmasının makara ve halatlar aracılığıyla asansör kabinine hareket gücü (tahrik) vermesine dayanır.

Machine room elevators are the most commonly used systems in our country and in the world. The principle of operation is mainly based on the mechanization of the motor-motor mechanics by means of pulleys and ropes to give movement to the elevator car.

Makine daireli asansörler; Asansör tahrik makinasının asansör kuyusunun üzerinde teşkil edilmiş bir oda içerisine bulundurulduğu asansör tipidir. Bu şekilde inşa edilen asansörler, insan asansörleri, yük asansörleri, araç asansörleri, sedye asansörleri, servis asansörleri gibi taşıma amaçlarına göre sınıflandırılabilirken, kontrol tarzına göre de çift hızlı, VVVF hız kontrollü olarak sınıflandırılabilirler.

Machine room elevators; It is the elevator type where the elevator drive machine is located in a room on the elevator shaft. The elevators constructed in this way can be classified according to their transportation purposes such as human lifts, hoists, vehicle lifts, stretcher elevators, service elevators, and they can be classified as double speed, VVVF speed control according to control style.

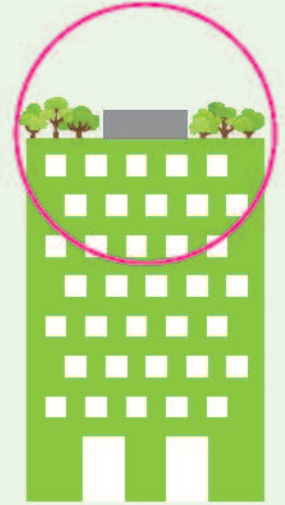

Makine dairesiz asansör Machine roomless lift

- Bina ile kolayca birleşir.
Easily converges with the building.
- Bina maliyetinden tasarruf sağlar.
Saves on building costs.
- Güvenli, esnek ve yenilikçi tasarım.
Safe, flexible and innovative design.
- Daha fazla tasarım özgürlüğü sunar.
It offers more design freedom.
- Daha fazla alan ve değer yaratır
Creates more space and value
- Geniş uygulama aralığı
Wide range of application

➤ Makine dairesiz asansör Machine roomless lift

Makine odasını iptal eder ve tüm asansörü kuyuya koyar. Mimarlar veya geliştiricilere ekipman alanı verir, alanın %40'ını azaltır. Bina estetiğini artırır, inşaat maliyetinden tasarruf sağlar.

The machine cancels the room and puts the entire elevator in the well. Provides equipment space to architects or developers, reducing 40% of space. Improves building aesthetics, saves construction costs.

- İnşaat alanının %10'unu kurtarır
Recovers 10% of the construction area
- Elektrik enerjisinin %40 tasarruf sağlar.
Saves up to 40% of electrical energy.
- Verimliliği %25 - %30'una artırır.
Increases productivity by 25% to 30%.



- 1) **Hedef katın giriş cihazı**
Input device of the target floor
- 1) **Hedef katın sıvı kristal ekranı üst salon kapısına monte edilmiştir. Ekran, asansörün gönderildiği ilgili zemini gösterir.**
The liquid crystal display of the target floor is mounted on the upper hall door. The display shows the relevant ground where the elevator is sent.
- 1) **Hedef katın rezervasyon ve yönlendirme sistemi**
Reservation and routing system of the target floor
Yolcu akışının yoğun olduğu saatlerde kaos koşulunu hafifletir
Relieves chaos conditions during peak hours of passenger flow
- 1) **Kaldırma, farklı hedef katlarına göre optimize edilmiştir. Yolcu akışını, yoğun saatlerde bile (önceki nesil sistemle karşılaştırıldığında) uygun şekilde azaltır.**
Lifting is optimized for different target levels. It reduces the passenger flow, even during peak hours (compared to the previous generation system).
- 1) **Birden fazla farklı hedef katlara gönderilmiş asansörün Park sürelerini azaltır ve yolculara daha hızlı servis sağlar.**
Reduced parking time of the elevator sent to multiple different target floors and provides faster service to passengers.

Onaylift Asansör

Asil ve heybetli yapılarınıza tarz katar.
It adds style to your noble and majestic structures.



Cabin
Collection



ONAYLIFT[®]
COMPONENTS

ONY-2201

ÖZELLİKLER

Kaplama : Sarı paslanmaz - Siyah paslanmaz
Aksesuar: Sarı paslanmaz
Tavan : Lazer kesim paslanmaz (T-200)
Taban : PVC AEZ-151
Ayna : Tam boy ayna

PROPERTIES

Coating : Gold stainless - Black stainless
Accessories: Gold stainless
Ceiling : Laser cut-indirect lighting (T-200)
Floor : PVC AEZ-151
Mirror : Full size



ONY-2202

ONAYLIFT
COMPONENTS

ÖZELLİKLER

Kaplama : Motif sarı ayna
Aksesuar : Sarı ayna
Tavan : Lazer kesim paslanmaz (T-181)
Taban : PVC AEZ-151
Ayna : Tam boy ayna

PROPERTIES

Coating : Gold mirror
Accessories: Gold mirror
Ceiling : Laser cut-indirect lighting (T-181)
Floor : PVC AEZ-151
Mirror : Full size



ONAYLIFT
COMPONENTS

ONY-2203

ÖZELLİKLER

Kaplama : Membran
Aksesuar: Sarı Ayna
Tavan : Lazer kesim paslanmaz (T-182)
Taban : Temper cam kaplama (CT-49)
Ayna : Tam boy ayna

PROPERTIES

Coating : Membrane
Accessories: Gold mirror
Ceiling : Laser cut-indirect lighting (T-182)
Floor : Tempered glass (CT-49)
Mirror : Full size



ONY-2204

ONAYLIFT
COMPONENTS

ÖZELLİKLER

Kaplama : Sarı satine - membran
Aksesuar: Sarı Ayna
Tavan : Lazer kesim paslanmaz (T-183)
Taban : PVC AEZ-151
Ayna : Tam boy ayna

PROPERTIES

Coating : Gold stainless membrane
Accessories: Gold mirror
Ceiling : Laser cut-indirect lighting (T-183)
Floor : PVC AEZ-151
Mirror : Full size



ONAYLIFT
COMPONENTS

ONY-2205

ÖZELLİKLER

Kaplama : Membran - Sarı dekostil
Aksesuar: Sarı Ayna
Tavan : Lazer kesim paslanmaz (T-184)
Taban : Temper cam kaplama (CT-55)
Ayna : Tam boy ayna

PROPERTIES

Coating : Membrane - Gold decorative
Accessories: Gold mirror
Ceiling : Laser cut-indirect lighting (T-184)
Floor : Tempered glass (CT-55)
Mirror : Full size



ONY-2206

ONAYLIFT
COMPONENTS

ÖZELLİKLER

Kaplama : Sarı dekostil
Aksesuar : Siyah Ayna
Tavan : Lazer kesim paslanmaz (T-185)
Taban : PVC AEZ-149
Ayna : Tam boy ayna

PROPERTIES

Coating : Gold decorative
Accessories: Black mirror
Ceiling : Laser cut-indirect lighting (T-185)
Floor : PVC AEZ-149
Mirror : Full size



ONAYLIFT[®]
COMPONENTS

ONY-2207

ÖZELLİKLER

Kaplama : Sarı satine - Siyah ayna
Aksesuar: Sarı satine
Tavan : Lazer kesim paslanmaz (T-186)
Taban : Granit - Star galaxy
Ayna : Tam boy ayna

PROPERTIES

Coating : Gold stainless - Black mirror
Accessories: Gold stainless
Ceiling : Laser cut-indirect lighting (T-186)
Floor : Granite - Star galaxy
Mirror : Full size



ONY-2208

ONAYLIFT
COMPONENTS

ÖZELLİKLER

Kaplama : Sarı satine
Aksesuar : Sarı Ayna paslanmaz
Tavan : Lazer kesim paslanmaz (T-187)
Taban : PVC AEZ-156
Ayna : Tam boy ayna

PROPERTIES

Coating : Gold stainless
Accessories: Gold mirror stainless
Ceiling : Laser cut-indirect lighting (T-187)
Floor : PVC AEZ-156
Mirror : Full size



ONAYLIFT[®]
COMPONENTS

ONY-2209

ÖZELLİKLER

Kaplama : Membran
Aksesuar : Ayna Paslanmaz
Tavan : Lazer kesim paslanmaz (T-188)
Taban : Granit (Hisar Gri)
Ayna : Tam boy ayna

PROPERTIES

Coating : Membrane
Accessories : Mirror stainless
Ceiling : Laser cut-indirect lighting (T-188)
Floor : Granite - (Hisar Gray)
Mirror : Full size



ONY-2210

ONAYLIFT
COMPONENTS

ÖZELLİKLER

Kaplama : Beyaz dekostil
Aksesuar : Siyah Ayna
Tavan : Lazer kesim paslanmaz (T-189)
Taban : Granit (Hisar Gri)
Ayna : Tam boy ayna

PROPERTIES

Coating : White decorative
Accessories: Black mirror
Ceiling : Laser cut-indirect lighting (T-189)
Floor : Granite (Hisar Gray)
Mirror : Full size



ONAYLIFT
COMPONENTS

ONY-2211

ÖZELLİKLER

Kaplama : Beyaz dekostil
Aksesuar: Ayna paslanmaz
Tavan : Lazer kesim paslanmaz (T-160)
Taban : Granit (Hisar Gri)
Ayna : Tam boy ayna

PROPERTIES

Coating : White decorative
Accessories: Mirror stainless
Ceiling : Laser cut-indirect lighting (T-160)
Floor : Granite (Hisar Gray)
Mirror : Full size



ONY-2212

ONAYLIFT
COMPONENTS

ÖZELLİKLER

Kaplama : Temper cam kaplama - Satine
Aksesuar : Süper Ayna
Tavan : Lazer kesim paslanmaz (T-190)
Taban : Granit (Hisar Gri)
Ayna : Tam boy ayna

PROPERTIES

Coating : Tempered glass - Stainless
Accessories: Super mirror
Ceiling : Laser cut-indirect lighting (T-190)
Floor : Granite (Hisar Gray)
Mirror : Full size



ONAYLIFT[®]
COMPONENTS

ONY-2213

ÖZELLİKLER

Kaplama : Siyah ayna paslanmaz-Sarı motif
Aksesuar: Ayna paslanmaz
Tavan : Lazer kesim paslanmaz (T-191)
Taban : Granit (Hisar Gri)
Ayna : Tam boy ayna

PROPERTIES

Coating : Black Mirror stainless
Accessories: Mirror stainless
Ceiling : Laser cut-indirect lighting (T-191)
Floor : Granite (Hisar Gray)
Mirror : Full size



ONY-2214

ONAYLIFT
COMPONENTS

ÖZELLİKLER

Kaplama : Satine - Siyah motif
Aksesuar : Satine
Tavan : Lazer kesim paslanmaz (bombeli)
Taban : Granit (Star Galaxy)
Ayna : Tam boy ayna

PROPERTIES

Coating : Black motif - Stainless
Accessories : Stainless
Ceiling : Laser cut-indirect lighting (dished)
Floor : Granite (Star Galaxy)
Mirror : Full size



ONAYLIFT
COMPONENTS

ONY-2215

ÖZELLİKLER

Kaplama : Satine motifli
Aksesuar : Süper Ayna
Tavan : Lazer kesim paslanmaz (T-192)
Taban : Granit (Hisar Gri)
Ayna : Tam boy ayna

PROPERTIES

Coating : Motif stainless
Accessories : Super mirror
Ceiling : Lazer cut-indirect lighting (T-192)
Floor : Granite (Hisar Gray)
Mirror : Full size



ONY-2216

ONAYLIFT
COMPONENTS

ÖZELLİKLER

Kaplama : Süper ayna paslanmaz
Aksesuar : Süper ayna paslanmaz
Tavan : Lazer kesim paslanmaz (T-193)
Taban : Granit (Aksaray yaylak)
Ayna : Tam boy ayna

PROPERTIES

Coating : Super mirror stainless
Accessories: Super mirror stainless
Ceiling : Laser cut-indirect lighting (T-193)
Floor : Granite (Aksaray yaylak)
Mirror : Full size



ONAYLIFT[®]
COMPONENTS

ONY-2217

ÖZELLİKLER

Kaplama : Satine paslanmaz
Aksesuar : Süper ayna paslanmaz
Tavan : Lazer kesim paslanmaz (T-124)
Taban : Granit (Hisar Gri)
Ayna : Tam boy ayna

PROPERTIES

Coating : Stainless steel
Accessories : Super mirror stainless
Ceiling : Laser cut-indirect lighting (T-124)
Floor : Granite (Hisar Gray)
Mirror : Full size



ONY-2218

ONAYLIFT
COMPONENTS

ÖZELLİKLER

Kaplama : Temper cam kaplama
Aksesuar : Sarı Ayna paslanmaz
Tavan : Lazer kesim paslanmaz (T-194)
Taban : Temper cam kaplama (CT-63)
Ayna : Tam boy ayna

PROPERTIES

Coating : Tempered glass
Accessories: Gold mirror stainless
Ceiling : Laser cut-indirect lighting (T-194)
Floor : Tempered glass (CT-63)
Mirror : Full size



ONAYLIFT
COMPONENTS

ONY-2219

ÖZELLİKLER

Kaplama : Sarı ayna paslanmaz - Lake
Aksesuar: Sarı ayna paslanmaz
Tavan : Lazer kesim paslanmaz (T-194)
Taban : Temper cam kaplama (CT-67)
Ayna : Tam boy ayna

PROPERTIES

Coating : Gold mirror stainless
Accessories: Gold mirror stainless
Ceiling : Laser cut-indirect lighting (T-194)
Floor : Tempered glass (CT-67)
Mirror : Full size



ONY-2220

ONAYLIFT
COMPONENTS

ÖZELLİKLER

Kaplama : Sarı ayna paslanmaz - Lake
Aksesuar : Sarı ayna paslanmaz
Tavan : Lazer kesim paslanmaz (T-144)
Taban : Temper cam kaplama (CT-68)
Ayna : Tam boy ayna

PROPERTIES

Coating : Gold mirror stainless
Accessories: Gold mirror stainless
Ceiling : Laser cut-indirect lighting (T-144)
Floor : Tempered glass (CT-68)
Mirror : Full size



ONAYLIFT[®]
COMPONENTS

ONY-2221

ÖZELLİKLER

Kaplama : Motif membran - Süper ayna paslanmaz
Aksesuar: Sarı ayna paslanmaz
Tavan : Lazer kesim paslanmaz (T-167)
Taban : Granit (Aksaray yaylak)
Ayna : Tam boy ayna

PROPERTIES

Coating : Motif membrane-Mirror stainless
Accessories: Gold mirror stainless
Ceiling : Laser cut-indirect lighting (T-167)
Floor : Granite (Aksaray yaylak)
Mirror : Full size



ONY-2222

ONAYLIFT
COMPONENTS

ÖZELLİKLER

Kaplama : Lamine - Doğal taş
Aksesuar : Sarı ayna paslanmaz
Tavan : Lazer kesim paslanmaz (T-195)
Taban : Temper cam kaplama (CT-69)
Ayna : Tam boy ayna

PROPERTIES

Coating : Lamine - Natural stone
Accessories: Gold mirror stainless
Ceiling : Laser cut-indirect lighting (T-195)
Floor : Tempered glass (CT-69)
Mirror : Full size



ONAYLIFT[®]
COMPONENTS

ONY-2223

ÖZELLİKLER

Kaplama : Sarı dekostil - Membran
Aksesuar: Sarı ayna paslanmaz
Tavan : Lazer kesim paslanmaz (T-196)
Taban : Temper cam kaplama (CT-70)
Ayna : Tam boy ayna

PROPERTIES

Coating : Gold decorative - Membrane
Accessories: Gold mirror stainless
Ceiling : Laser cut-indirect lighting (T-196)
Floor : Tempered glass (CT-70)
Mirror : Full size



ONY-2224

ONAYLIFT
COMPONENTS

ÖZELLİKLER

Kaplama : Membran
Aksesuar : Sarı ayna paslanmaz
Tavan : Lazer kesim paslanmaz (T-162)
Taban : PVC AEZ-156
Ayna : Tam boy ayna

PROPERTIES

Coating : Membrane
Accessories: Gold mirror stainless
Ceiling : Laser cut-indirect lighting (T-162)
Floor : PVC AEZ-156
Mirror : Full size



ONAYLIFT[®]
COMPONENTS

ONY-2225

ÖZELLİKLER

Kaplama : Membran
Aksesuar : Sarı ayna paslanmaz
Tavan : Lazer kesim paslanmaz (T-197)
Taban : Temper cam kaplama (CT-71)
Ayna : Tam boy ayna

PROPERTIES

Coating : Membrane
Accessories : Gold mirror stainless
Ceiling : Laser cut-indirect lighting (T-197)
Floor : Tempered glass (CT-71)
Mirror : Full size



ONY-2226

ONAYLIFT
COMPONENTS

ÖZELLİKLER

Kaplama : Sarı dekostil - Membran
Aksesuar : Sarı ayna paslanmaz
Tavan : Lazer kesim paslanmaz (T-198)
Taban : PVC AEZ-152
Ayna : Tam boy ayna

PROPERTIES

Coating : Gold decorative - Membrane
Accessories : Gold mirror stainless
Ceiling : Laser cut-indirect lighting (T-198)
Floor : PVC AEZ-152
Mirror : Full size



ONAYLIFT[®]
COMPONENTS

ONY-2227

ÖZELLİKLER

Kaplama : Membran
Aksesuar : Bakır ayna paslanmaz
Tavan : Lazer kesim paslanmaz (T-124)
Taban : PVC-01
Ayna : Tam boy ayna

PROPERTIES

Coating : Membrane
Accessories : Copper mirror stainless
Ceiling : Lazer cut-indirect lighting (T-124)
Floor : PVC-01
Mirror : Full size



ONY-2228

ONAYLIFT
COMPONENTS

ÖZELLİKLER

Kaplama : Motif Membran
Aksesuar : Süper ayna paslanmaz
Tavan : Lazer kesim paslanmaz (T-146)
Taban : Granit (Hisar gri)
Ayna : Tam boy ayna

PROPERTIES

Coating : Motif Membrane
Accessories: Super mirror stainless
Ceiling : Laser cut-indirect lighting (T-146)
Floor : Granite (Hisar gray)
Mirror : Full size



ONAYLIFT
COMPONENTS

ONY-2229

ÖZELLİKLER

Kaplama : Lamine
Aksesuar : Süper ayna paslanmaz
Tavan : Lazer kesim paslanmaz (T-199)
Taban : PVC-01
Ayna : Tam boy ayna

PROPERTIES

Coating : Laminate
Accessories : Super mirror stainless
Ceiling : Laser cut-indirect lighting (T-199)
Floor : PVC-01
Mirror : Full size



ONY-2230

ONAYLIFT
COMPONENTS

ÖZELLİKLER

Kaplama : Yaldız lake
Aksesuar : Sarı ayna paslanmaz
Tavan : Lazer kesim paslanmaz (bombeli)
Taban : Temper cam kaplama (CT-55)
Ayna : Tam boy ayna

PROPERTIES

Coating : Gilding lacquer
Accessories: Gold mirror stainless
Ceiling : Laser cut-indirect lighting (dished)
Floor : Tempered glass (CT-55)
Mirror : Full size



ONAYLIFT[®]
COMPONENTS

ONY-2231

ÖZELLİKLER

Kaplama : Membrane - Doğal taş
Aksesuar : Bakır paslanmaz
Tavan : Lazer kesim paslanmaz (T-145)
Taban : PVC-01
Ayna : Tam boy ayna

PROPERTIES

Coating : Membrane - Natural stone
Accessories : Copper stainless
Ceiling : Laser cut-indirect lighting (T-145)
Floor : PVC-01
Mirror : Full size



ONY-2232

ONAYLIFT
COMPONENTS

ÖZELLİKLER

Kaplama : Satine paslanmaz - Smart
Aksesuar : Satine paslanmaz
Tavan : Lazer kesim paslanmaz (T-192)
Taban : Granit (Hisar gri)
Ayna : Tam boy ayna

PROPERTIES

Coating : Stainless steel -Smart
Accessories: Stainless steel
Ceiling : Laser cut-indirect lighting (T-192)
Floor : Granite (Hisar gray)
Mirror : Full size



ONAYLIFT
COMPONENTS

ONY-2233

ÖZELLİKLER

Kaplama : Temperli cam
Aksesuar: Sarı ayna paslanmaz
Tavan : Lazer kesim paslanmaz (T-160)
Taban : Temper cam kaplama (CT-47)
Ayna : Tam boy ayna

PROPERTIES

Coating : Tempered glass
Accessories: Gold mirror stainless
Ceiling : Lazer cut-indirect lighting (T-160)
Floor : Tempered glass (CT-47)
Mirror : Full size

ONLY-2234



ONLY-2235



ONLY-2236



ONLY-2237



ONLY-2238



ONLY-2239

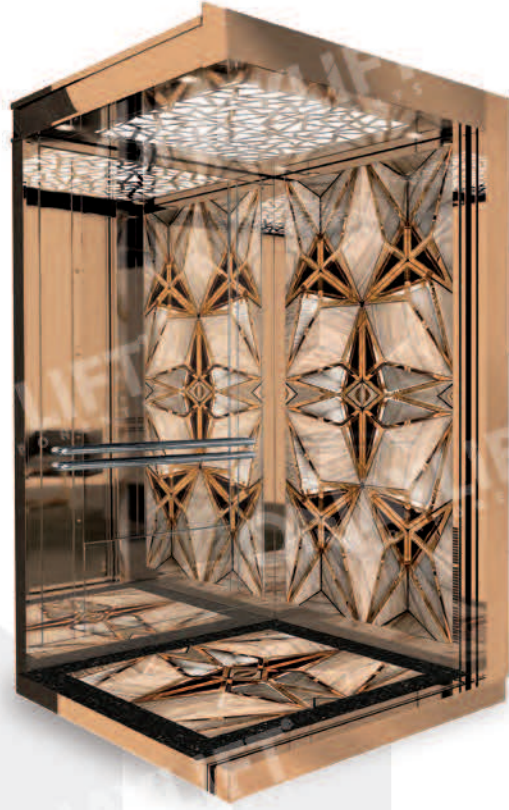

ONLY-2240



ONLY-2241



ONY-2242



ONY-2243



ONY-2244



ONY-2245





ONAYLIFT[®]
COMPONENTS

ONY-2246

ÖZELLİKLER

Kaplama : ESB boya
Aksesuar : Satine paslanmaz
Tavan : Lazer kesim - ESB boya
Taban : PVC

PROPERTIES

Coating : ESB ral paint
Accessories : Stainless
Ceiling : Laser cut - ESB ral paint
Floor : PVC

ONLY-2247



ONLY-2248



ONLY-2249



ONLY-2250





OCM-2246

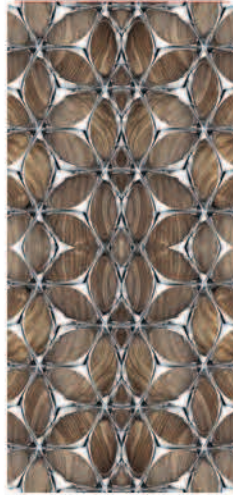

OCM-2247



OCM-2248



OCM-2249



OCM-2250



OCM-2251



OCM-2252

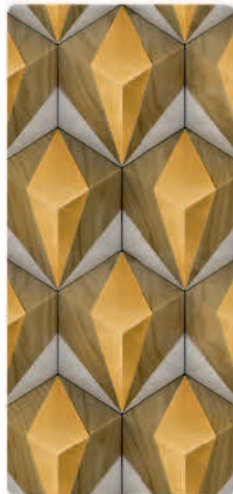

OCM-2253



OCM-2254



OCM-2255



OCM-2256

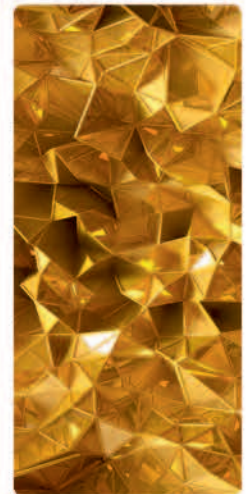

OCM-2257



OCM-2258

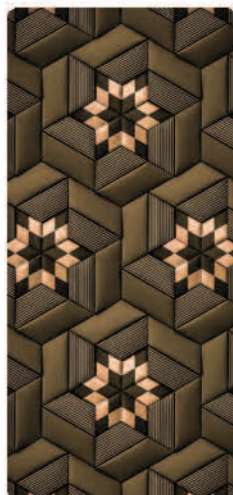

OCM-2259

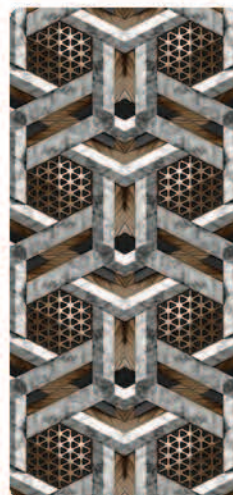

OCM-2260

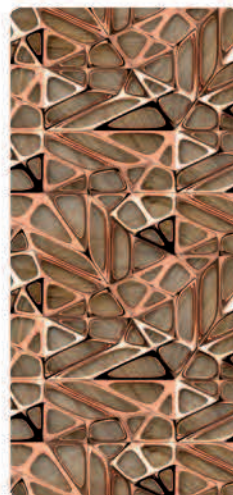

OCM-2261

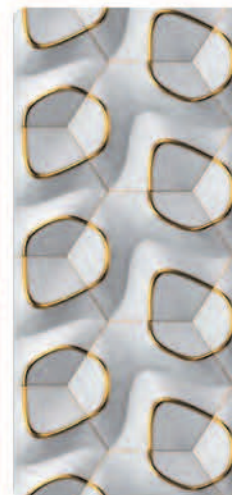

OCM-2262



OCM-2263

Tempered Glass

Temperli Cam Kaplama



OCM-2264



OCM-2265

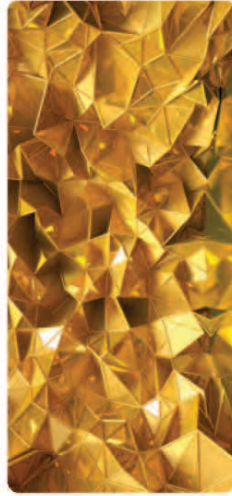

OCM-2266



OCM-2267



OCM-2268



OCM-2269



OCM-2270



OCM-2271



OCM-2272



OCM-2273



OCM-2274



OCM-2275



OCM-2276



OCM-2277



OCM-2278



OCM-2279



OCM-2280



OCM-2281



T-144



T-145

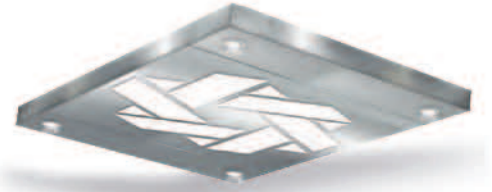

T-146

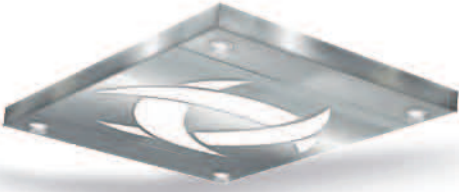

T-147



T-148

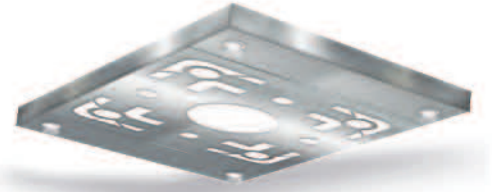

T-149



T-150



T-151



T-152

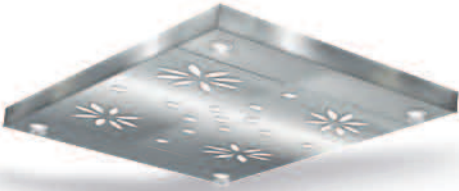

T-153

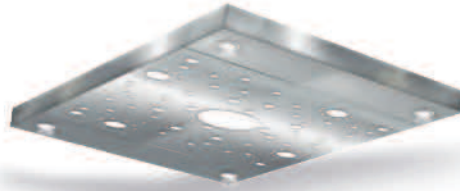

T-154



T-155

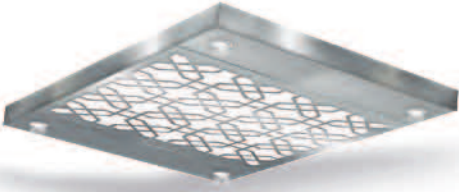

T-156

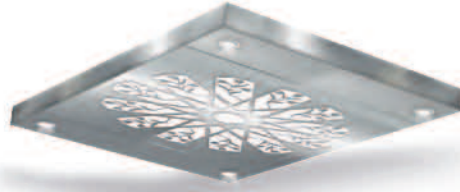

T-157



T-158

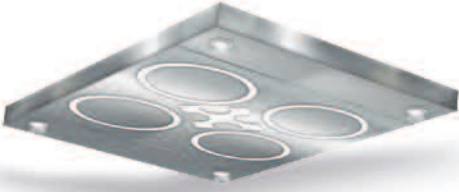

T-159



T-160

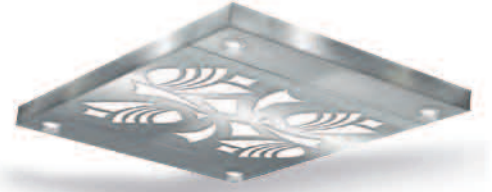

T-161

Ceiling Design

Tavan Tasarımları

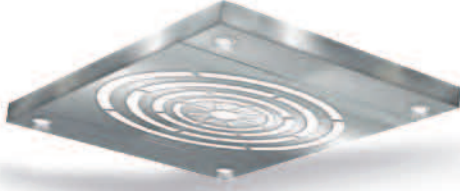

T-162



T-163

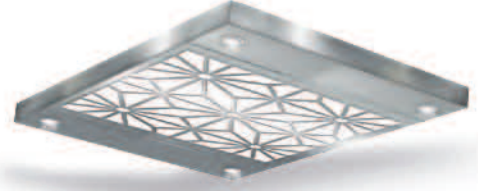

T-164



T-165



T-166

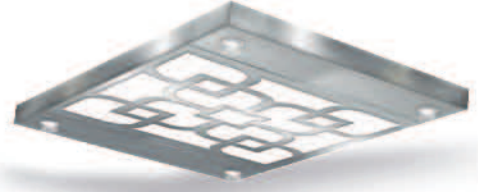

T-167



T-168

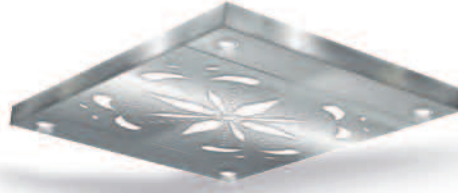

T-169

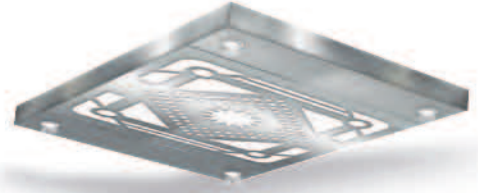

T-170



T-171



T-172



T-173



T-174

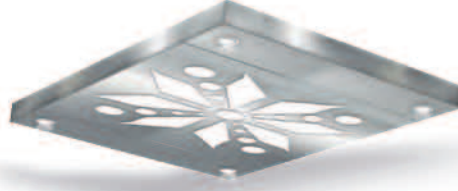

T-175



T-176

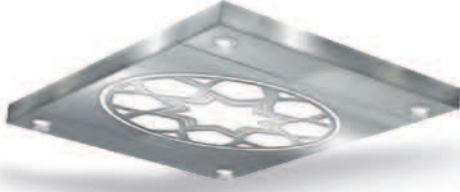

T-177



T-178

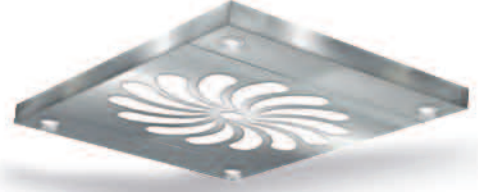

T-179

Granit | Granite

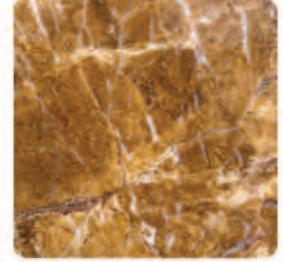
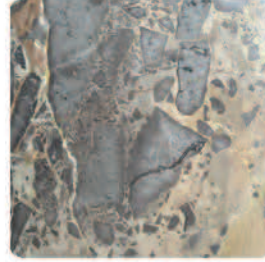
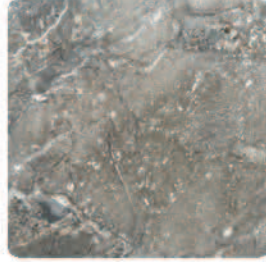
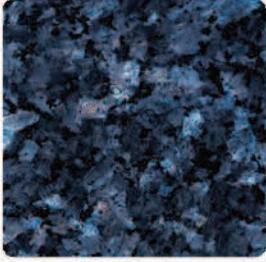

DAKOTA BROWN

ELDORADO GREY

EREY GREY

GOLDEN BRONZE

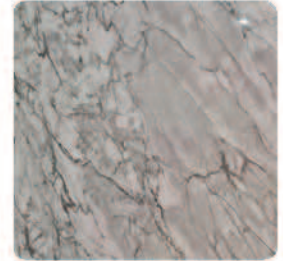
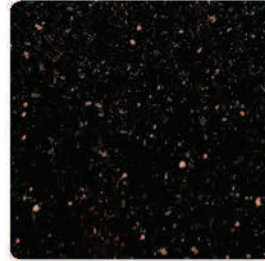
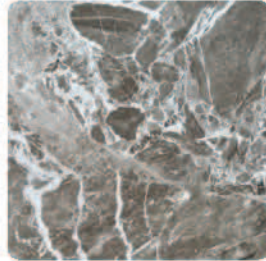
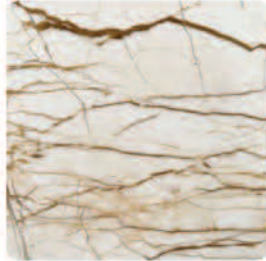
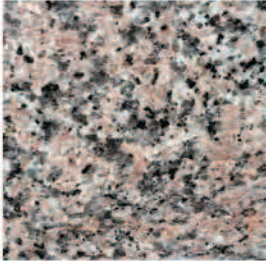

ROSA PORINHO

SOFİTA

SPİDER GREY

STAR GALAXY

SUPREME WHITE

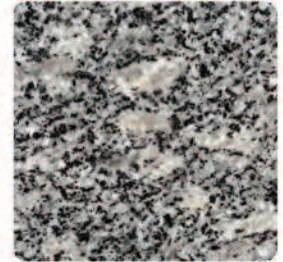
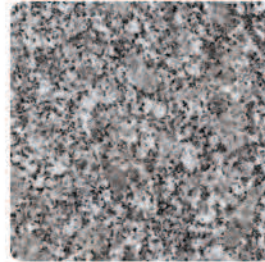
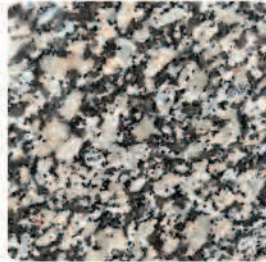
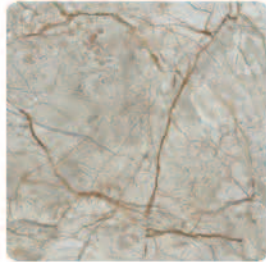
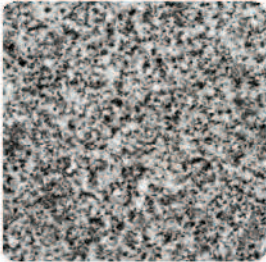

HİSAR GRİ

MELİSA BEJ

ROSA MİNHÔ

AKSARAY YAYLAK

ANKARA FÜME

Cam | Glass

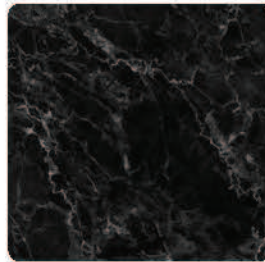
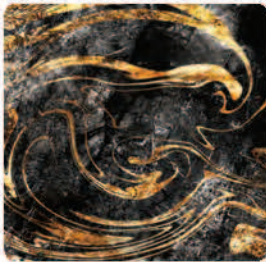
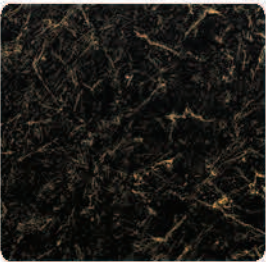

CT-47

CT-48

CT-49

CT-50

CT-51

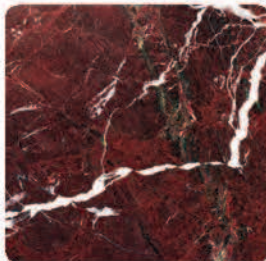

CT-52

CT-53

CT-54

CT-55

CT-56

Floor Design

Taban Tasarımları

PVC | PVC

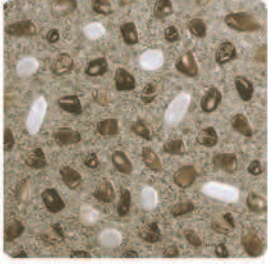

PVC-ES-5

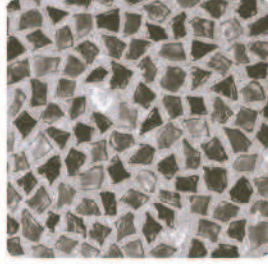

PVC-3714

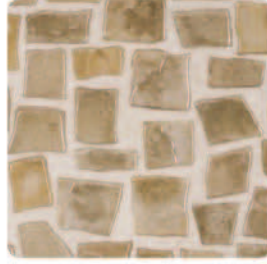

PVC-1341



PVC-01



PVC-02



PVC-04



PVC-05

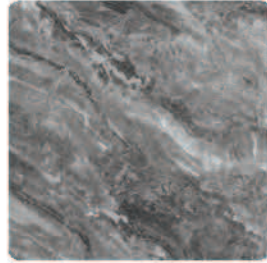

PVC-06

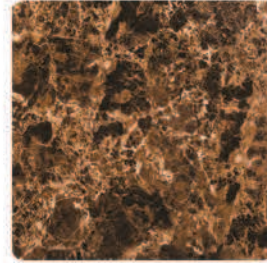

PVC-07

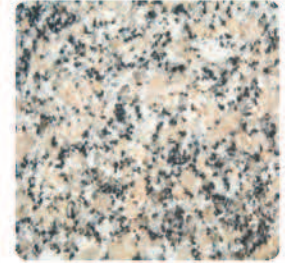

PVC-08



PVC-03

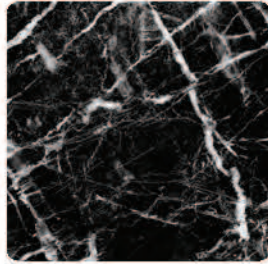

PVC-09



PVC-AEZ-154



PVC-AEZ-149



PVC-AEZ-151

Cam | Glass

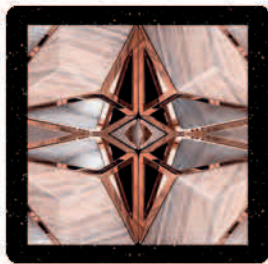

CT-57



CT-58



CT-59



CT-60



CT-61

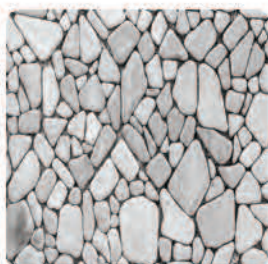

CT-62



CT-63



CT-64



CT-65

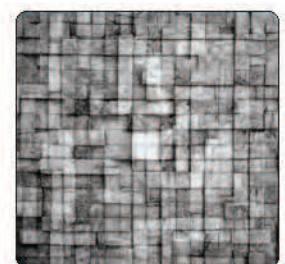

CT-66

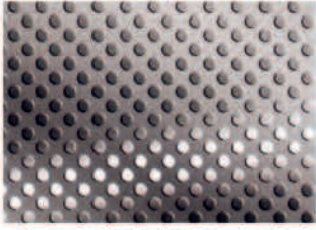

DM-09

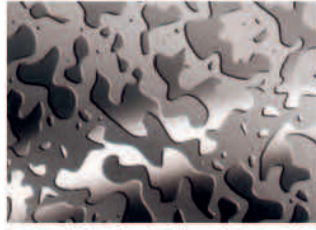

DM-05



DM-13



DM-04



DM-02



DM-03



DM-24



E-58

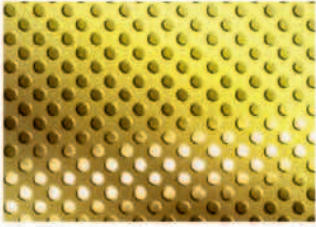

DG NOKTA

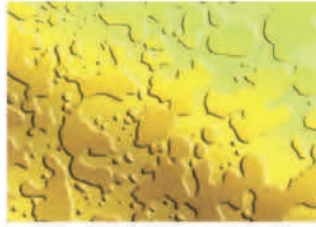

DG-05



DG-02

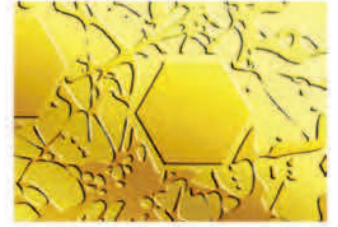

DG-06



DG-03



DG-15



DM-17



DM-10



DM-15

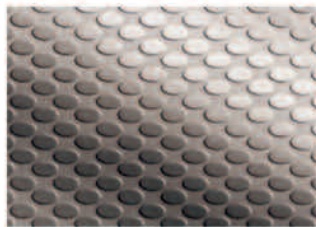

DM-09



DM-21

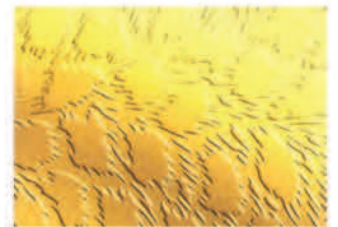

DG-25



DG-10



DG-01

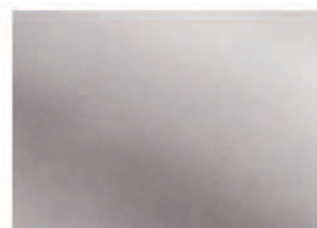

DM-01

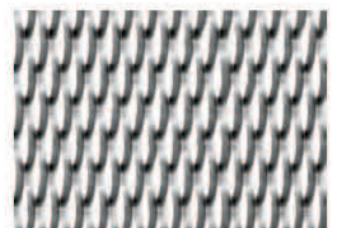

5-WL

Laminate Coating

Laminant Kaplama



105 P



106 P

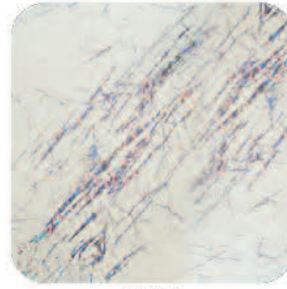

610 P

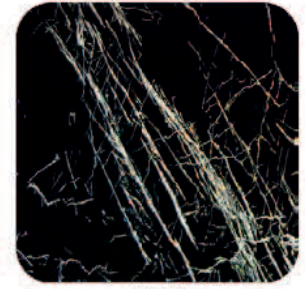

612 P



248 B

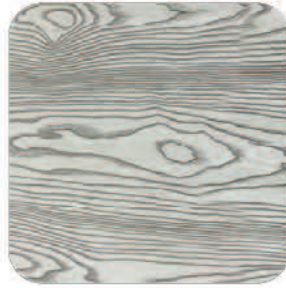

250 B



252 B



065 B



073 P



076 P



085 P



093 P



4208



4267



4428



4513



4514



4523



4544



4605

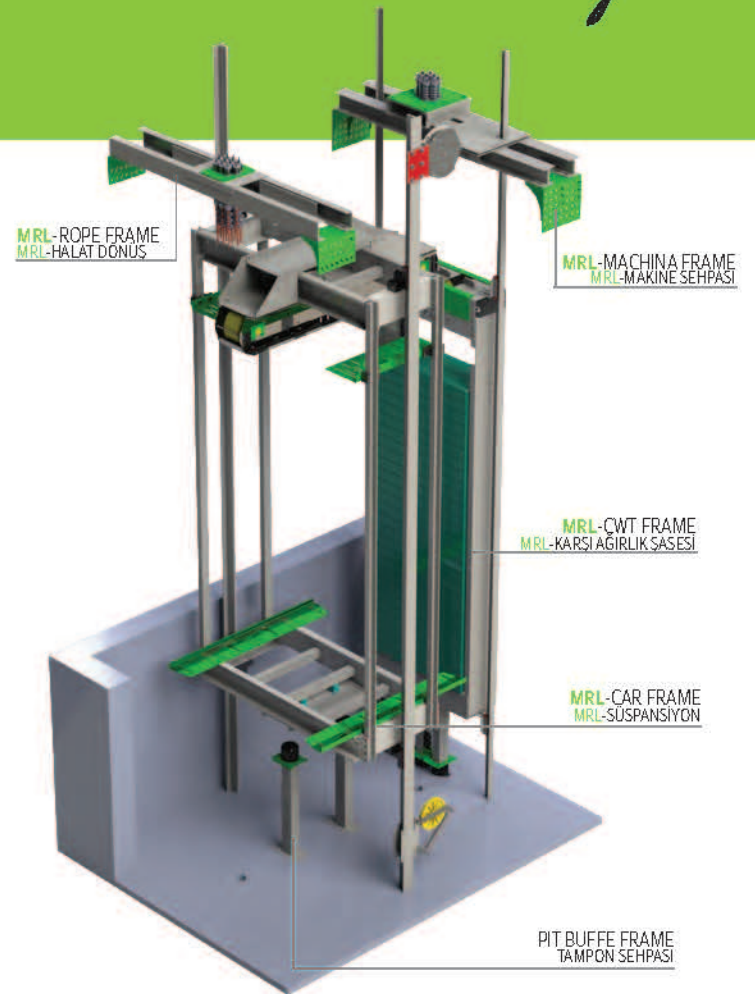
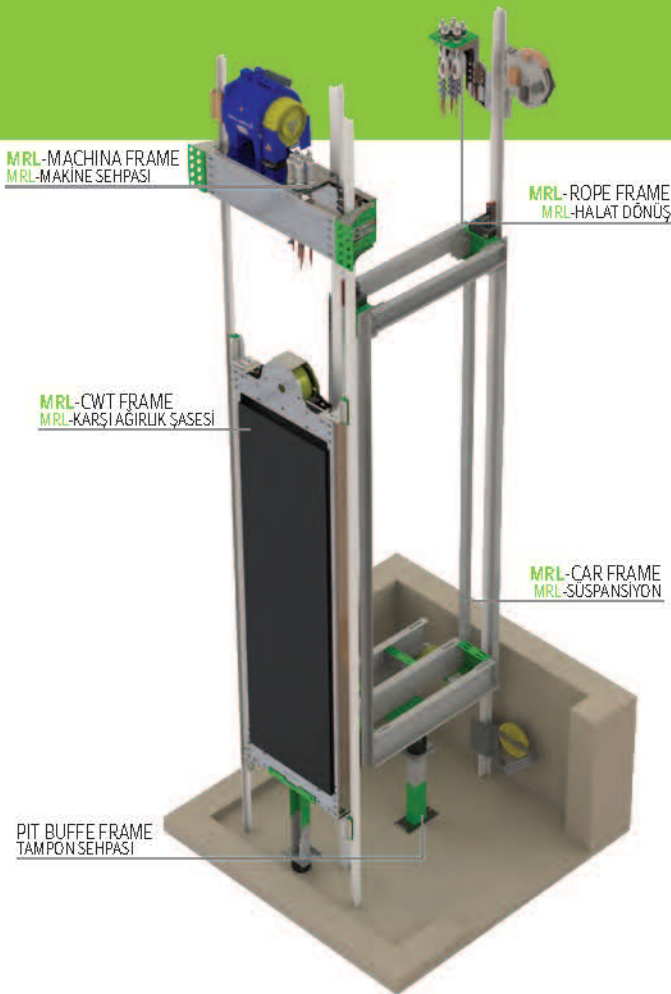

Teknik özellikler / Technical Specifications

Capacity	320 Kg	400 Kg	450 Kg	630 Kg	800 Kg	1000 Kg	1275 Kg	1600 Kg	2000 Kg	2500 Kg	3000 Kg	3500Kg
No Of Passengers	4	5	6	8	10	13	17	20	27	33		
Roping	2:1	2:1	2:1	2:1	2:1	2:1	2:1	2:1	2:1	4:1	4:1	4:1
Max. Car Area (m2)	0,9	1,17	1,3	1,66	2	2,4	2,9	3,56	3,57	4,3	5,1	5,9
Man. Car Area (m2)	0,79	0,98	1,17	1,45	1,73	2,15	2,57	3,13	4,2	5	5,8	6,6
Person	*	*	*	*	*	*	*	*	*	*	*	*
Load And Cargo						*	*	*	*	*	*	*
Pit Depth - Standart (mm)	1200 mm											
Pit Depth - Special (mm)	Min - 300 mm - Max - 1100 mm											
Headroom - Standart (mm)	Min - 3800 mm - Max - 6000 mm											
Headroom - Special (mm)	Min - 2800 mm - Max - 3700 mm											
Door Type	Semi Automatic - Automatic - Brushless Automatic											
Control Panel	Arkel (A drive - Arcode - Arcube) - Microlift											
Traction System	GEARLESS MACHINE VVVF											
Guide Rail	T50 - T70 - T90 - T125 - T127											

MRL System

En MRL system is a new generation electric elevator system that offers an ideal solution for residential, commercial and public buildings based on innovative modular design. The MRL system is designed to provide the most appropriate space usage and energy consumption in buildings.

Tr MRL sistem yenilikçi modüler tasarıma dayanan konut, ticari ve kamu binaları için ideal çözüm sunan yeni nesil elektrikli asansör sistemidir. MRL sistem binalarda en uygun alan kullanımı ve enerji tüketimini sağlamak için tasarlanmıştır.

MR System

En It is the preferred system in high-rise buildings with a machine room. Driving and sound comfort are at the forefront of this system. It has been designed and produced according to your wall (well) dimensions.

Tr Makine dairesi ile birlikte yükselen katlı binalarda tercih edilen sistemdir. Sürüş ve ses konforu bu sistemde ön plandadır. Sizin duvar (kuyu) ölçülerinize göre tasarlanarak üretilmiştir.

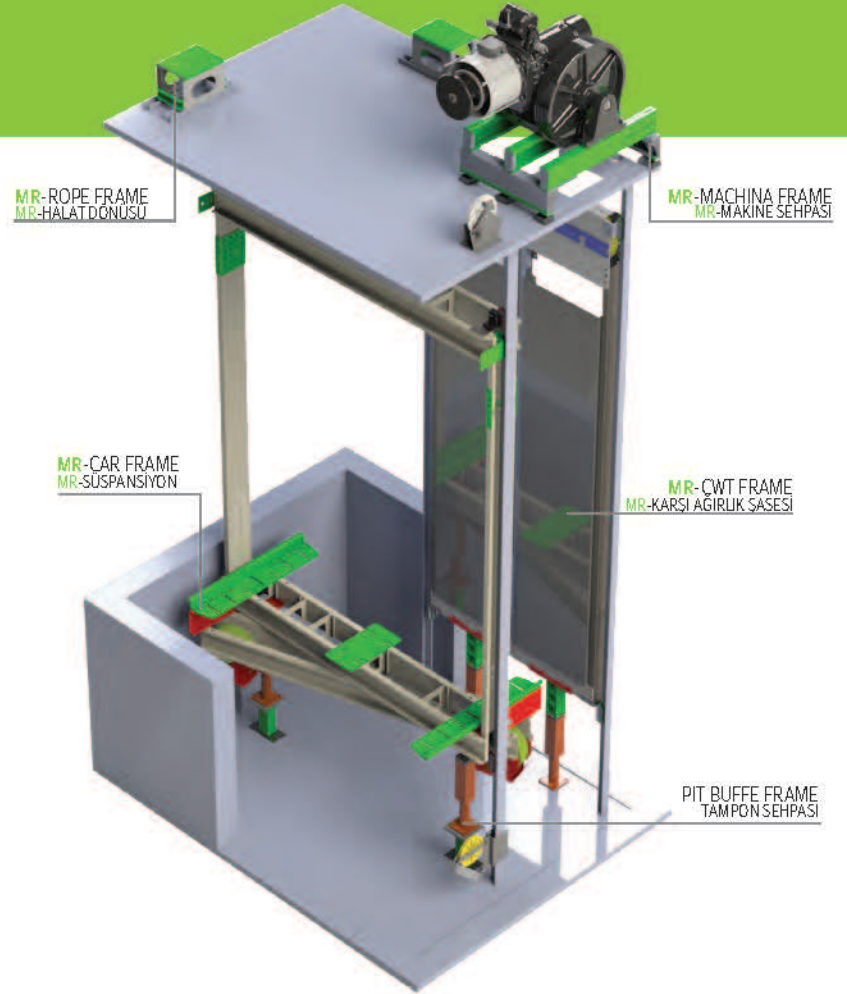

Teknik özellikler / Technical Specifications

Capacity	320 Kg	400 Kg	450 Kg	630 Kg	800 Kg	1000 Kg	1275 Kg	1600 Kg	2000 Kg	2500 Kg	3000 Kg	3500Kg
No Of Passengers	4	5	6	8	10	13	17	20	27	33		
Roping	1:1	1:1	1:1	1:1	1:1	1:1	2:1	2:1	2:1	4:1	4:1	4:1
Max. Car Area (m2)	0,9	1,17	1,3	1,66	2	2,4	2,9	3,56	3,57	4,3	5,1	5,9
Man. Car Area (m2)	0,79	0,98	1,17	1,45	1,73	2,15	2,57	3,13	4,2	5	5,8	6,6
For Person	*	*	*	*	*	*	*	*	*	*	*	*
For Load And Cargo						*	*	*	*	*	*	*
Pit Depth - Standart (mm)	1200 mm											
Pit Depth - Special (mm)	Min - 300 mm - Max - 1100 mm											
Headroom - Standart (mm)	Min - 3800 mm - Max - 6000 mm											
Headroom - Special (mm)	Min - 2800 mm - Max - 3700 mm											
Door Type	Semi Automatic - Automatic - Brushless Automatic											
Control Panel	Arkel (A drive - Arcode - Arcube) - Microlift											
Traction System	GEARBOX MACHINE VVVF											
Guide Rail	T50 - T70 - T90 - T125 - T127											

**Merkezi 2 Panel
Kabin Kapısı (Fırçasız)**

Central Opening 2 Panel
Cabin Door (Brushless)



Automatic Door Otomatik Kapılar

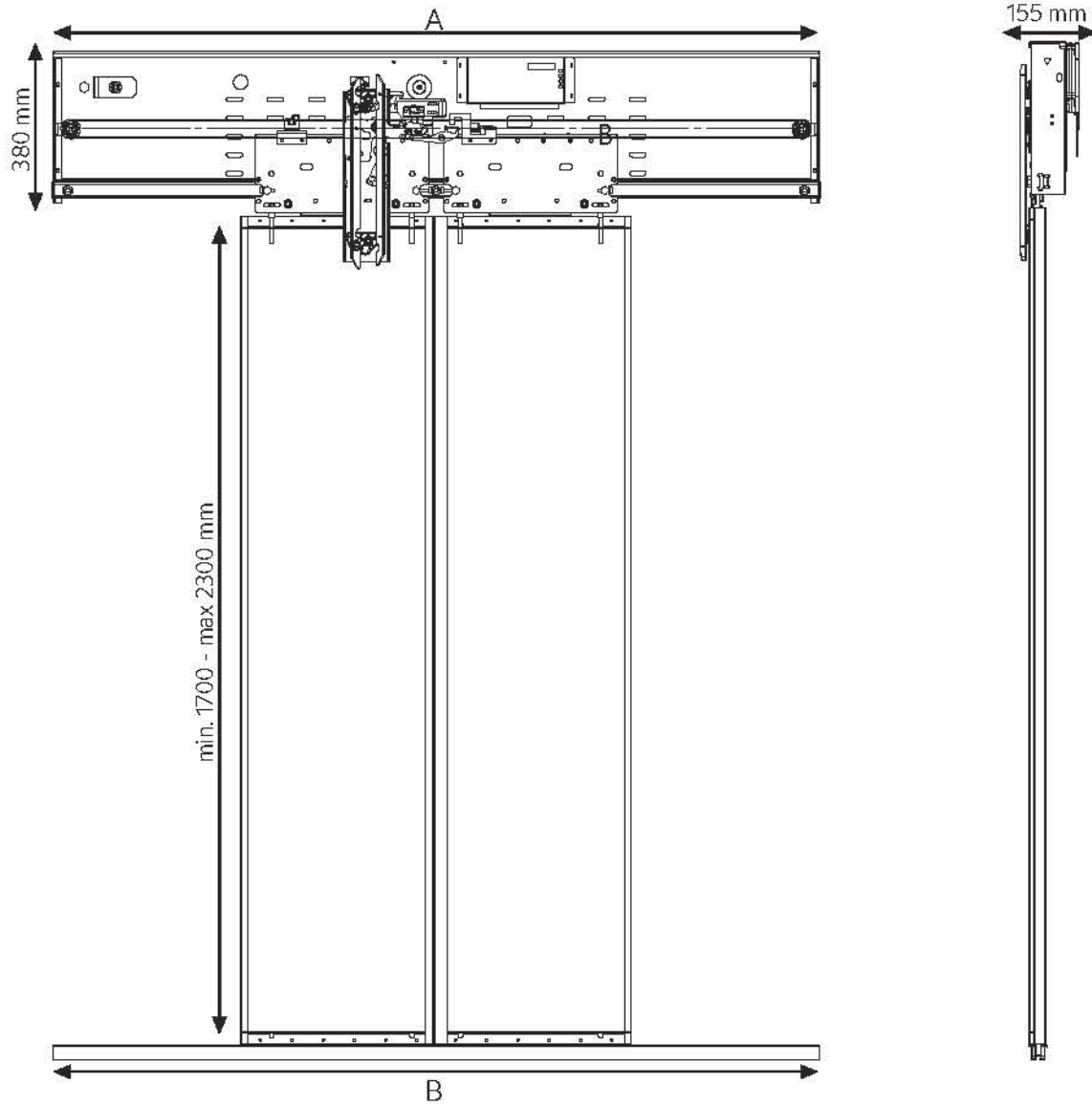

Ölçüler / Dimensions

	A (mm)	B (mm)
70	1470	1420
80	1670	1620
90	1890	1820
100	2070	2020
110	2370	2220
120	2570	2420
130	2770	2620

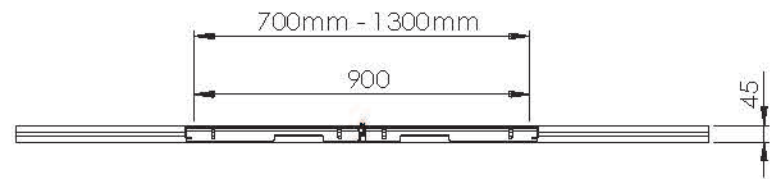

**Merkezi 2 Panel
Kabin Kapısı**

Central Opening 2 Panel
Cabin Door



Automatic Door Otomatik Kapılar

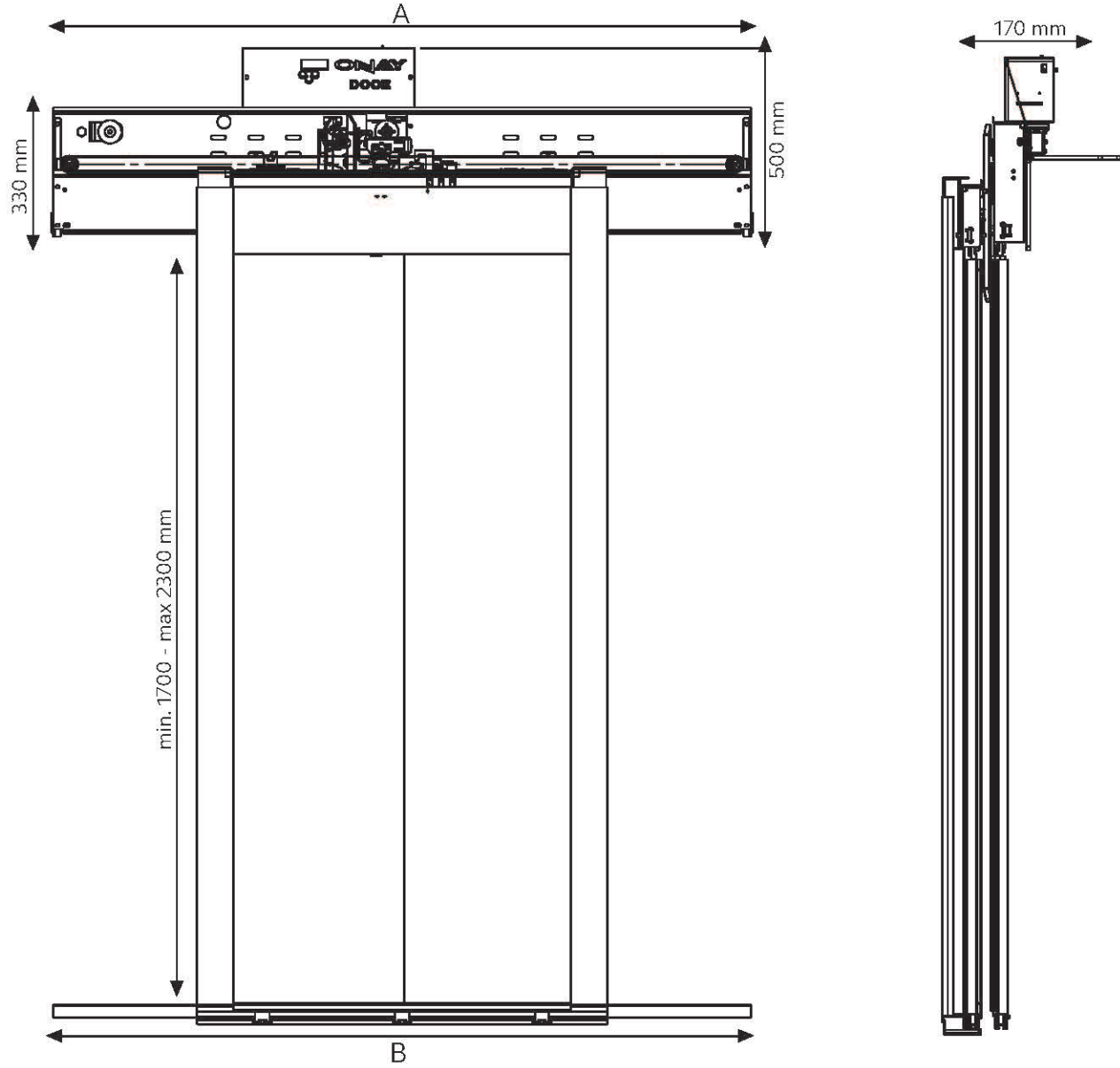

Ölçüler / Dimensions

	A (mm)	B (mm)
70	1470	1420
80	1670	1620
90	1890	1820
100	2070	2020
110	2370	2220
120	2570	2420
130	2770	2620

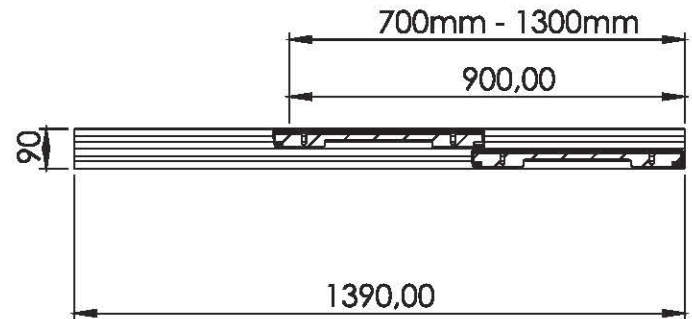

**Teleskopik 2 Panel
Kabin Kapısı (Fırçasız)**

Teleskopik 2 Panel
Cabin Door (Brushless)



Automatic Door Otomatik Kapılar

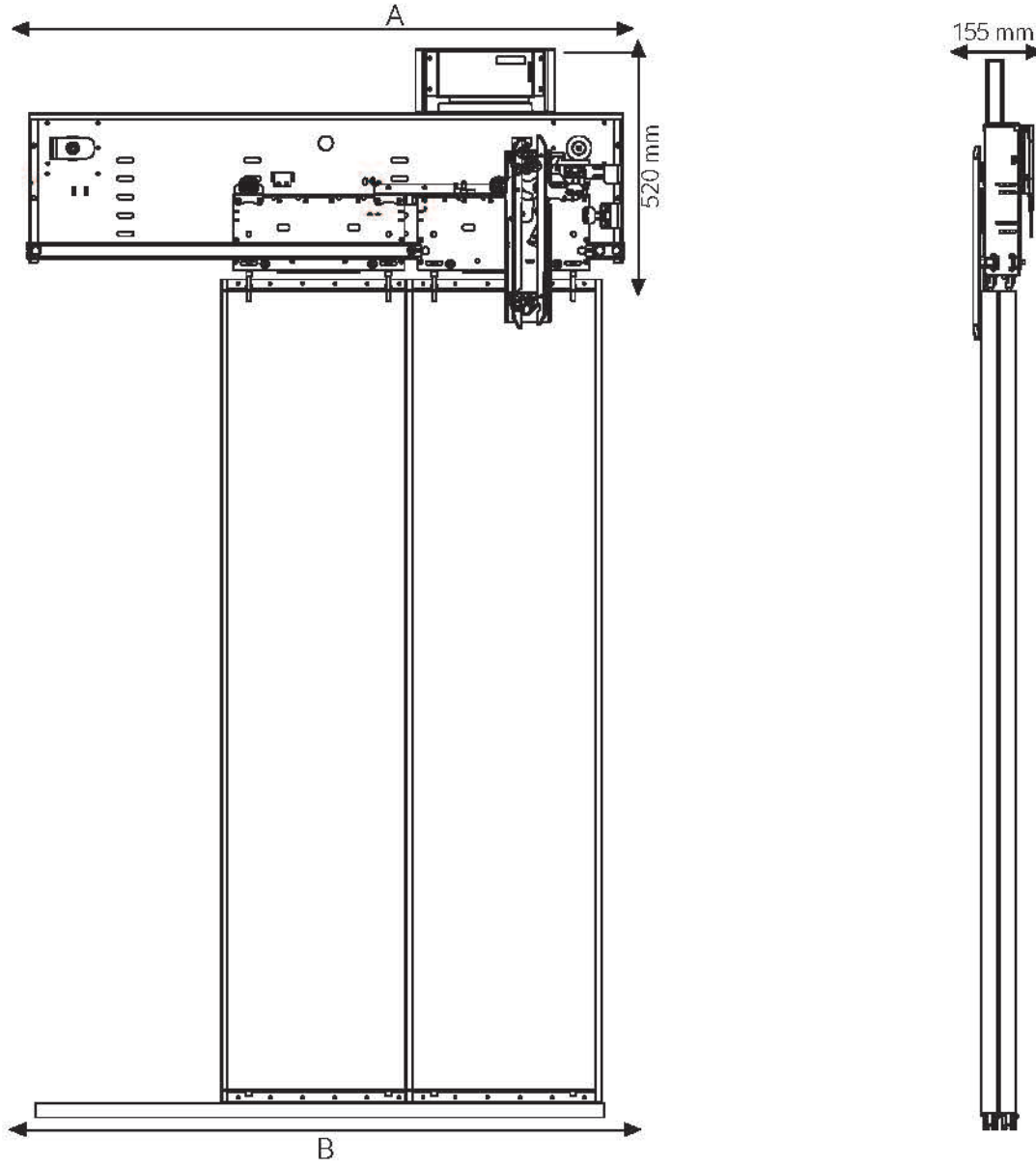

Ölçüler / Dimensions

	A (mm)	B (mm)
70	1140	1065
80	1290	1215
90	1440	1365
100	1590	1515
110	1740	1665
120	1890	1815
130	2040	1965

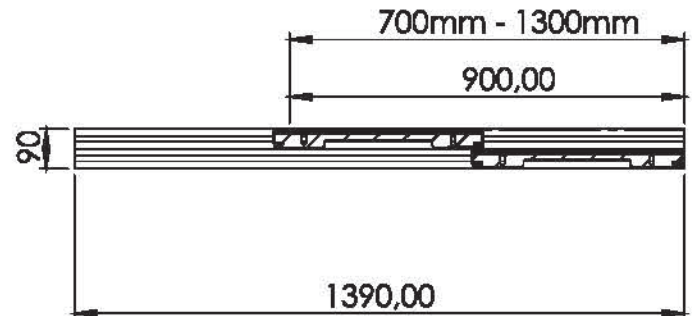

**Teleskopik 2 Panel
Kabin Kapısı**

Teleskopik 2 Panel
Cabin Door



Automatic Door Otomatik Kapılar

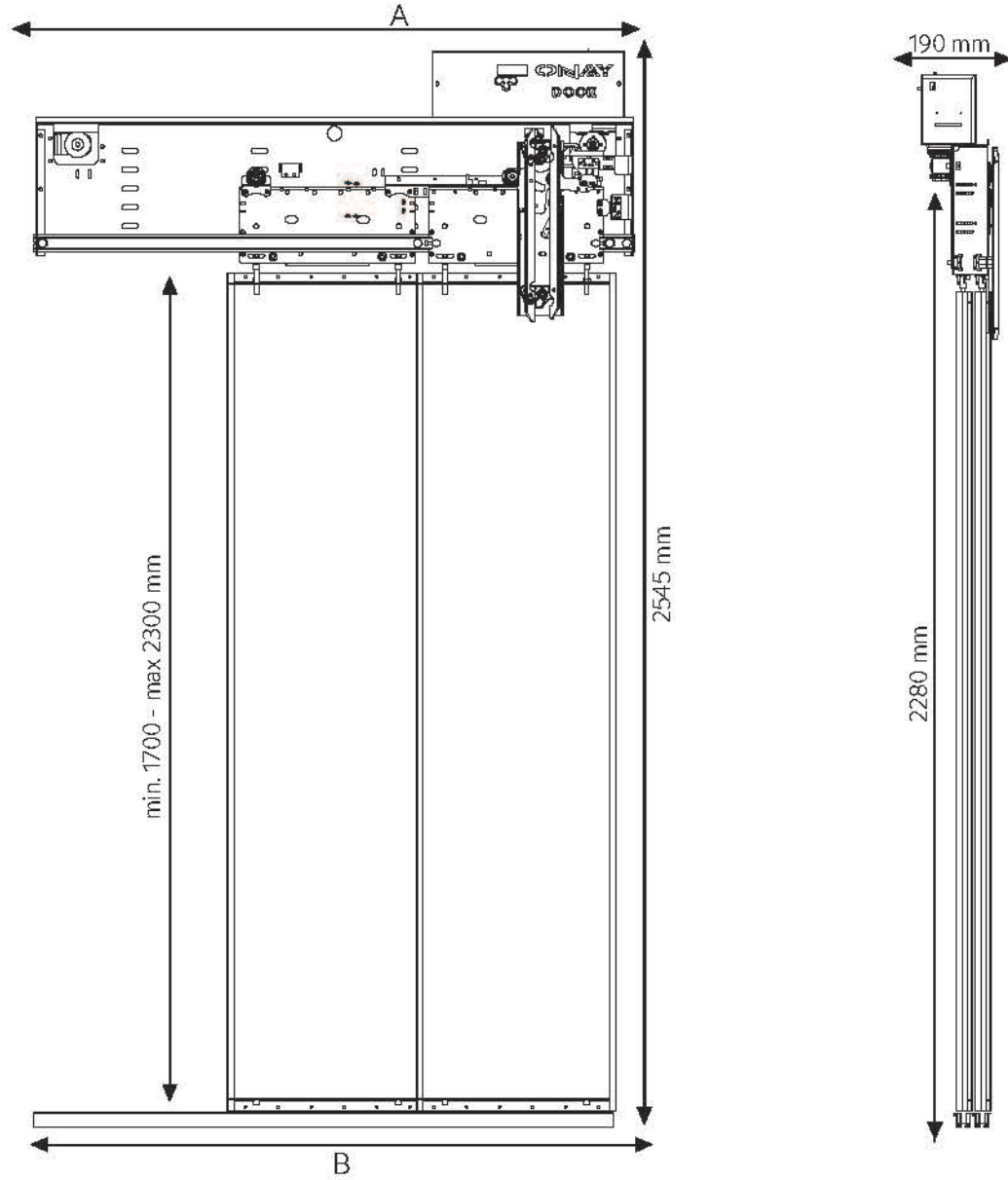

Ölçüler / Dimensions

	A (mm)	B (mm)
70	1140	1065
80	1290	1215
90	1440	1365
100	1590	1515
110	1740	1665
120	1890	1815
130	2040	1965

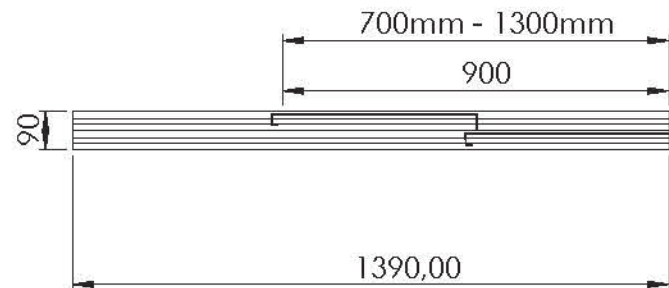

**Merkezi 2 Panel
Kat Kapısı**
Central Opening 2 Panel
LadingDoor

Automatic Door Otomatik Kapılar

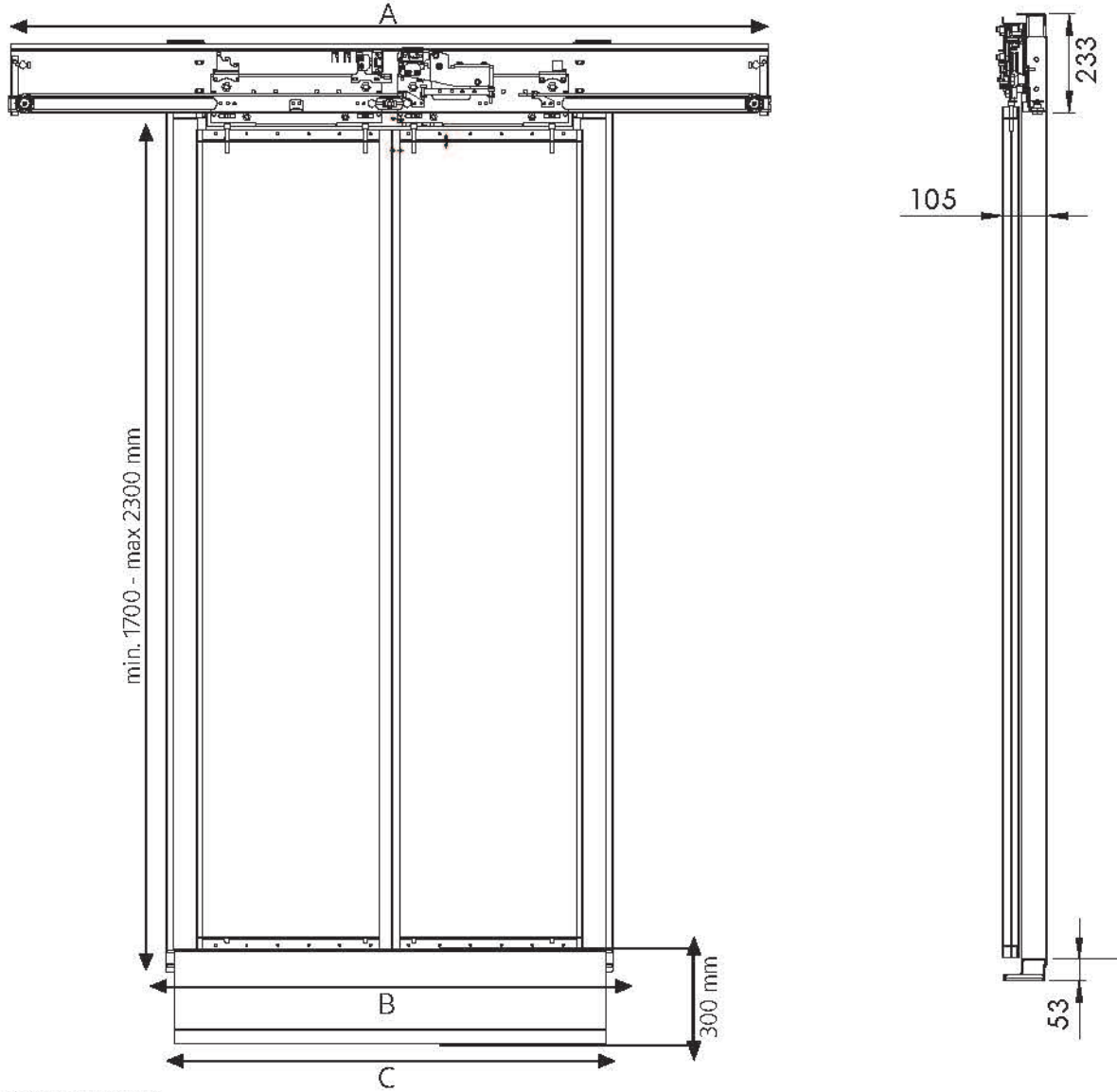

Ölçüler / Dimensions

	A (mm)	B (mm)	C (mm)
70	1470	1420	800
80	1670	1620	900
90	1890	1820	1000
100	2070	2020	1100
110	2370	2220	1200
120	2570	2420	1300
130	2770	2620	1400

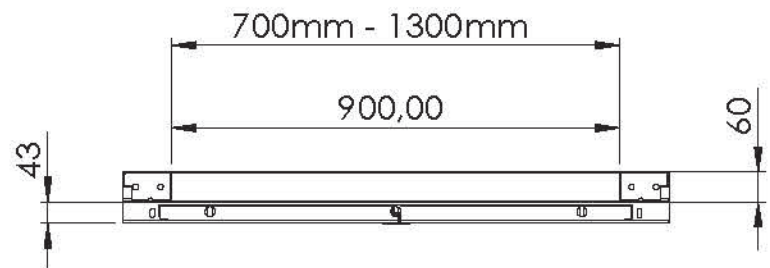

**Teleskopik 2 Panel
Kat Kapısı**

Teleskopik 2 Panel
Landing Door



Automatic Door Otomatik Kapılar

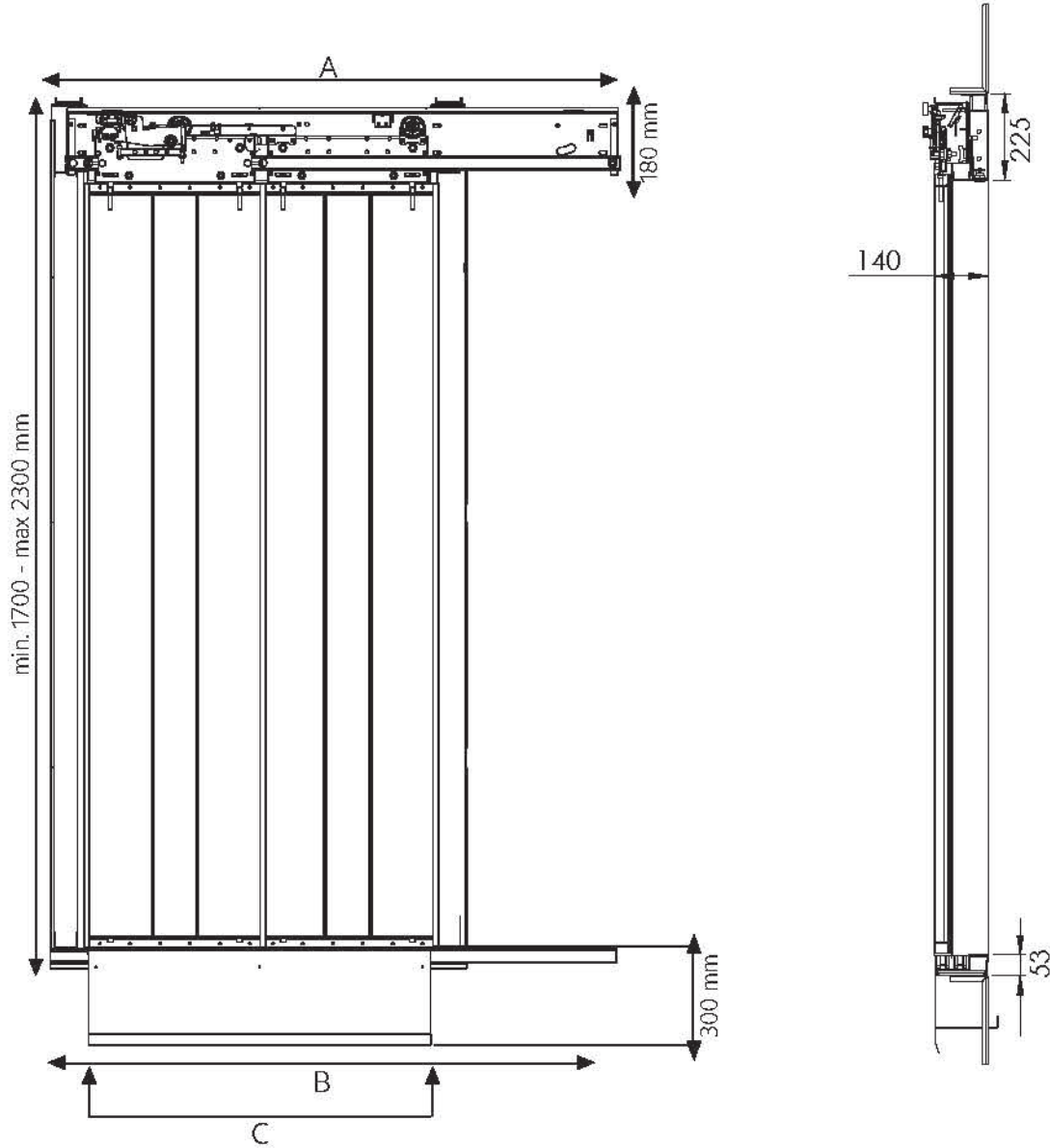

Ölçüler / Dimensions

	A (mm)	B (mm)	C (mm)
70	1160	1065	800
80	1310	1215	900
90	1460	1365	1000
100	1610	1515	1100
110	1760	1565	1200
120	1910	1815	1300
130	2060	1955	1400

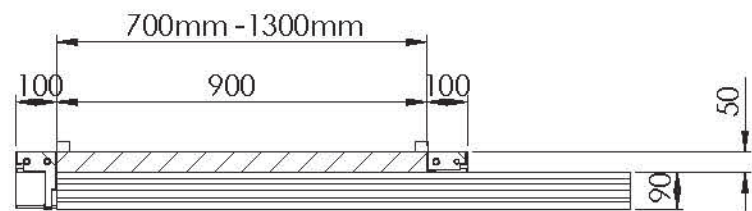



Landing Door

Kat Kapıları

Onaylift yarı otomatik kat kapıları genellikle yapının durumunun müsait olmadığı ve daha ekonomik çözümler ile asansör yapılmak istendiğinde tercih edilir.

The semi-automatic floor doors are generally preferred when the structure is not suitable and the elevator is desired to be made with more economical solutions.



CK-116



CK-117



CK-118



CK-119



CK-120



CK-121



CK-122



CK-123



CK-124



CK-125



CK-126



CK-127



CK-128



CK-129



CK-130



CK-131

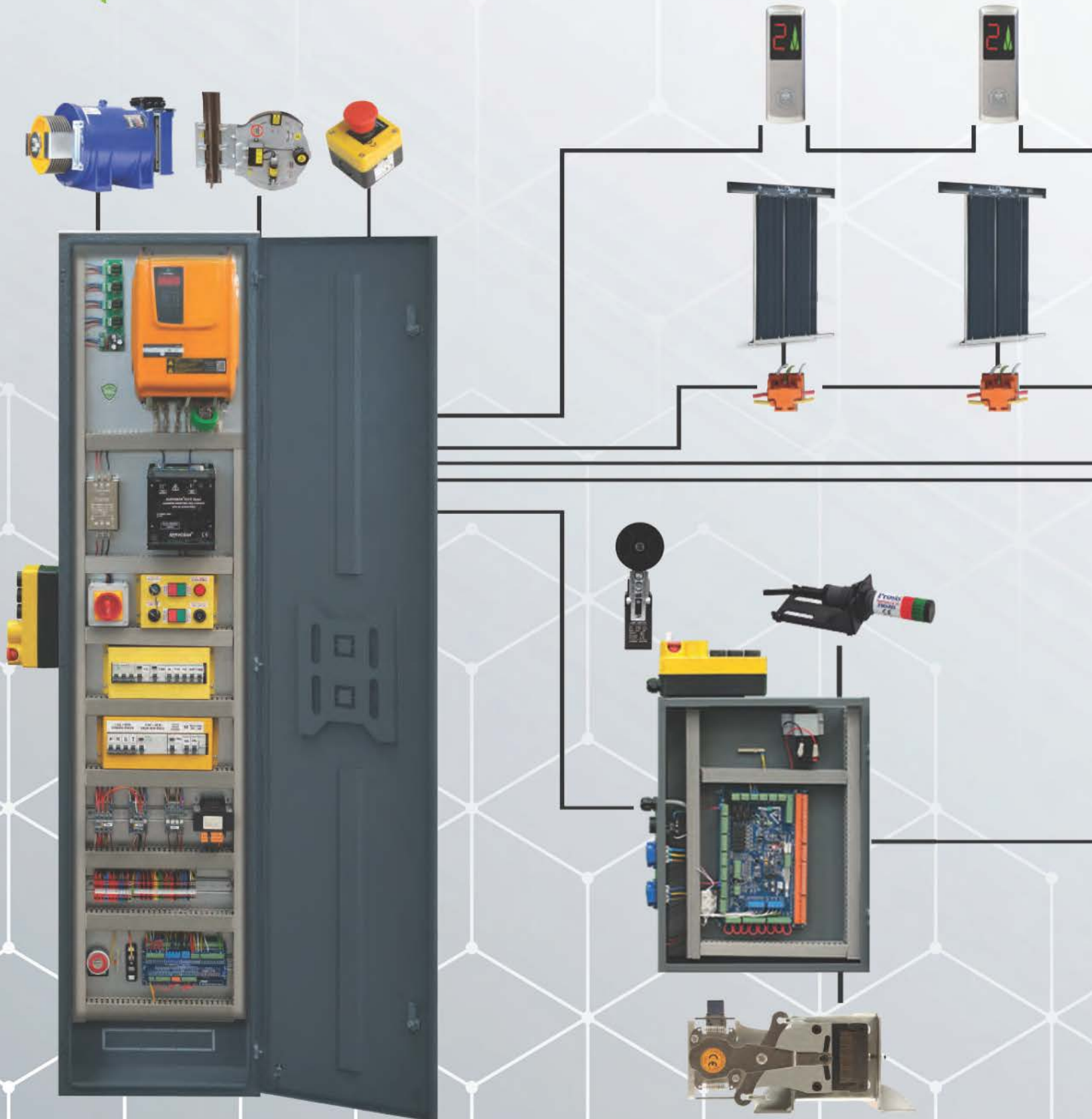

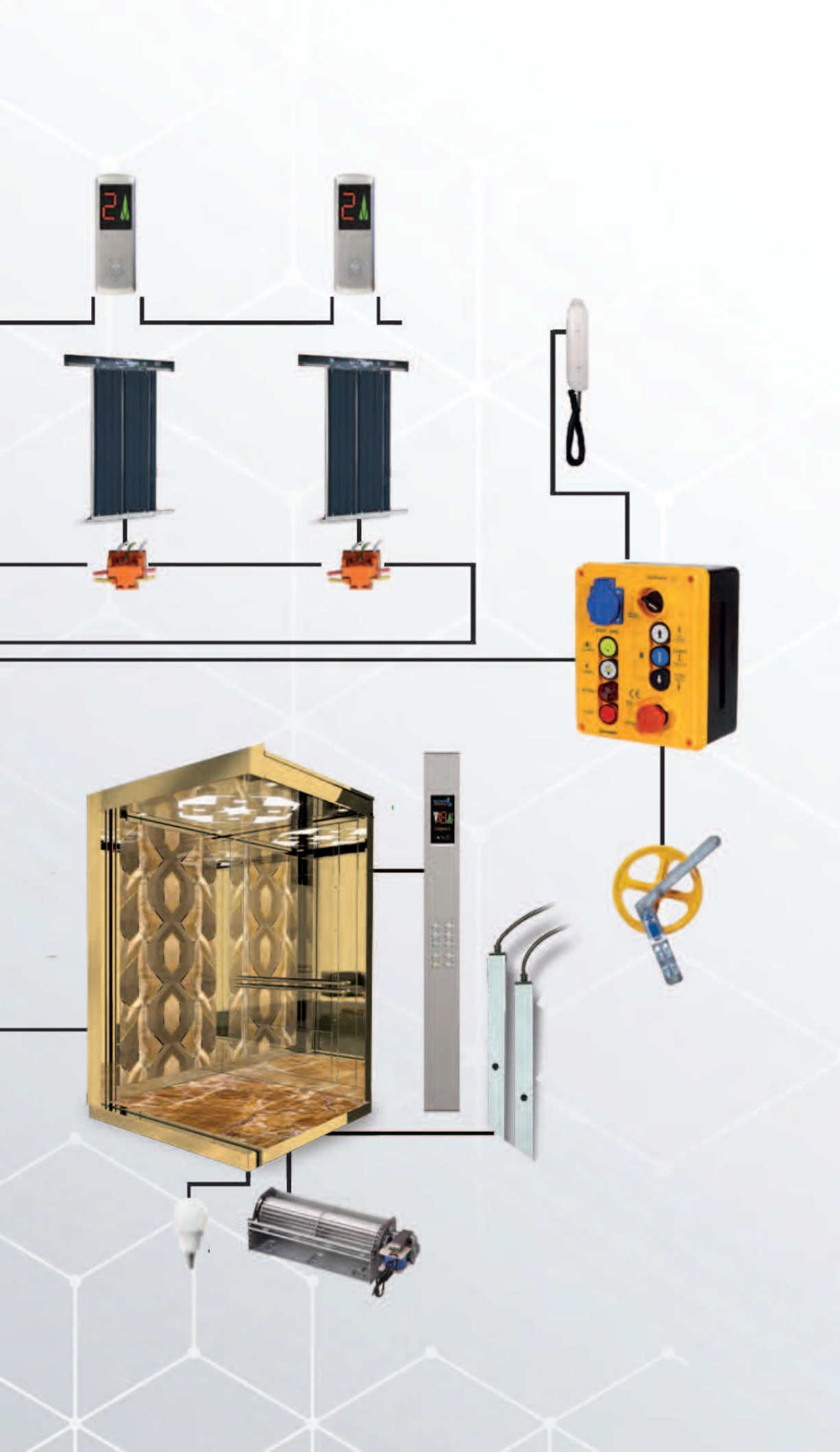

PRE-WIRING

HAZZIB
Tesisat



**Dişlisiz Pano (MRL)
Gearless Control Panel (MRL)**



EI Terminali | AREM Terminal



ARLINE Uzaktan İzleme, Alarm ve İnterkom Sistemi | ARLINE System

**Dişli Pano (MR)
Geared Control Panel (MR)**



Control Panels Kumanda Panoları

Özellikler

Asansör Hızı: 4 m/s
Durak Sayısı: 64 Durak
Motor Kontrolü: Senkron (dişlisiz)
Makine, Asenkron (dişli) Makine
Seri Haberleşme: Hazır Tesisatlı CANbus
Seri Haberleşmeli ile (standart)
Otomatik Kata Getirme: 1-Faz 220 VAC
UPS Akü Grubu Bağlantısı
Grup Çalışılma Özelliği: 8 Asansöre Kadar
Tahrik Tipi: Makine Daireli, Makine Dairesiz (MRL)
Enkoder: Artırımsal Enkoder(5V TTL veya 10-30V HTL)
Mutlak Enkoder(EnDat, SSI, SinCos veya BISS)

Features

Elevator Spee: 4m/s
Number of Stops: 64 Stops
Motor Control: Synchronous (gearless)
Machine, Asynchronous
Automatic Bring to Floor: 1-Faz 220VAC UPS
Accumulator Group Connection
Drive Type: With or Without Engine Room (MRL)
Group Work Feature: Up to 8 elevators
Serial Communication: With Ready Installation
CANbus Serial Communication (Standard)
Encoder: Incremental Encoder (5V TTL or 10-30V HTL)
Absolute Encoder (EnDat, SSI, SinCos or BISS)

MRL Slim

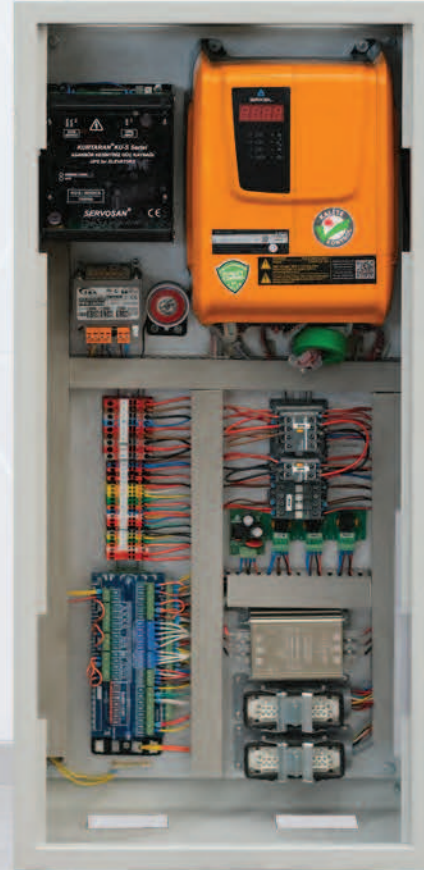

Özellikler

- Kolay ve hızlı pano yapımı
- Tüm emniyet devresi sinyallerinin LED ile izlenmesi
- Direkt duruş
- Mükemmel sürüş ve duruş kontrolü
- EN81-20 Standardı'na uygunluk
- Dahili EMC filtre
- Tüm emniyet devresi sinyallerinin LED ile izlenmesi
- Hassas motor tanıma
- SD kartla sahada güncelleme
- Minimum ve basit parametrelerle kolay devreye alma
- Asansörün tüm hareketlerinin (opsiyonel) müşteri CLOUD'una depolanması

Features

- Fast and easy panel construction
- Monitoring all safety circuit signals by LED
- Direct stop
- Excellent drive and stop control
- Suitable with EN81-20 Standard
- Internal EMC filter
- Precise motor identification
- Update in the field with SD card
- Storing all elevator movements (optional) in customer cloud
- Easy set up and installation with minimum and simple parameters

Dişlisiz Pano (MRL)
Gearless Control Panel (MRL)



Dişli Pano (MR)
Geared Control Panel (MR)

Paralel Tesilat Revizyon Kutusu
Parallel Installation Revision Box

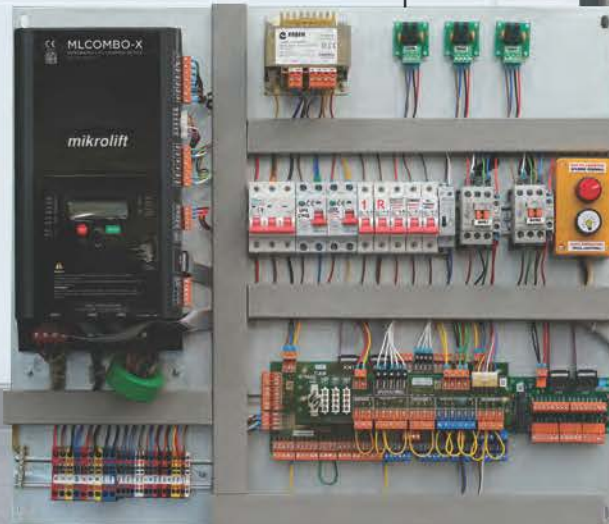

Control Panels

Kumanda Panoları

Özellikler

- Güç Devri: 60-120 V gerilimli akü grubu 220 VAC çıkışlı uygun güçte bir UPS beslenebilir
- Aşırı Hız Uyarısı: 0,63 m/s' den yüksek hızlarda
- Hata Kaydı: Son 256 hatanın hafızada tutulmasıyla geçmişe dönük anıza takip imkanı
- Standartlara Uygunluk: EMC test sertifikası
- Kontrol Devresi: Harici 24 Vdc besleme ile canlı kalabilir
- Seri Haberleşme: ARL-500 kumanda kartı ile RS-485 portu üzerinde seri haberleşme

Features

- Power Circuit: 60-120V battery pack can be powered by a UPS with 220VAC output power
- Over Speed Warning: At high speeds of 0,63 m/s
- Error Record: Ability to trace back to the past with the last 256 errors kept in memory
- Compliance to Standards: EMC test certified
- Control Circuit: Viability with external 24Vdc supply
- Serial Communication: Serial communication via RS-485 port with ARL-500 control card

Paralel Tesiat Revizyon Kutusu
Parallel Installation Revision Box



Dişlisiz Pano (MRL)
Gearless Control Panel (MRL)



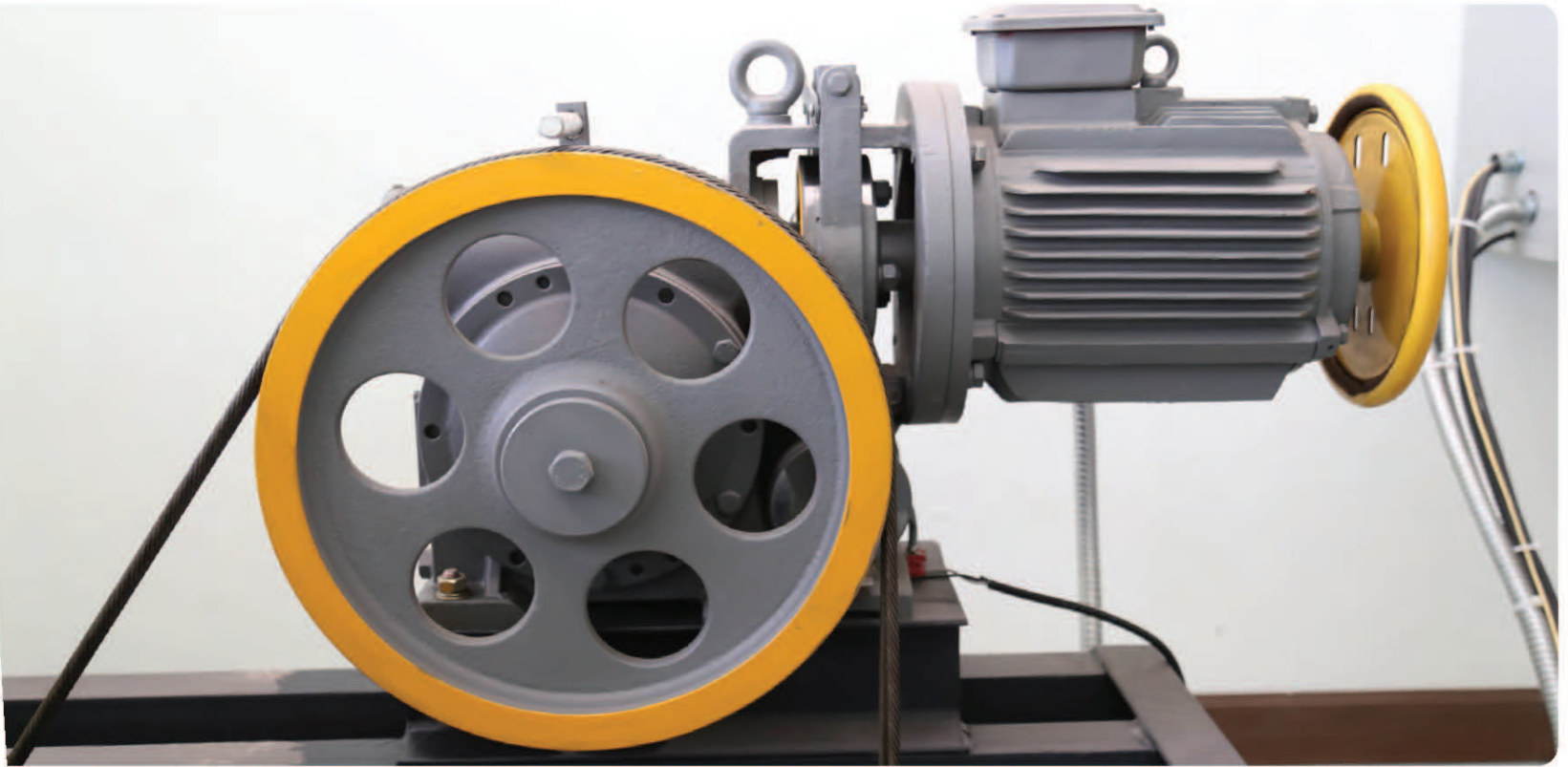

AKIS-ZF82



AKIS MUGEN MF-1



AKIS AK-2



Z-60 TAMBURLU



CSAG-D



CSAG-K



CSAG-M

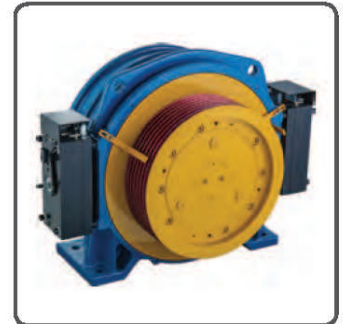

CSAG-T

Machine Motor Makine Motor



GEM-135B



GEM-140D



GEM-WTD-2

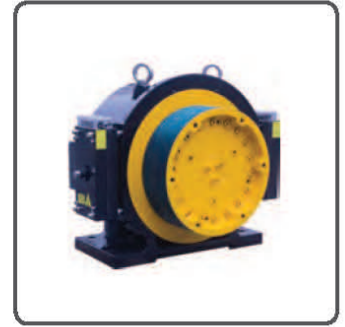

GEM-WTD-1



SASSI-TORO



SASSI-MODY



SASSI-S38



SASSI-G200-T1



SICOR-VS630



SICOR-S2V1250



SICOR-SV480



SICOR-SMRL480



MONTERANI-M83



MONTERANI-M85

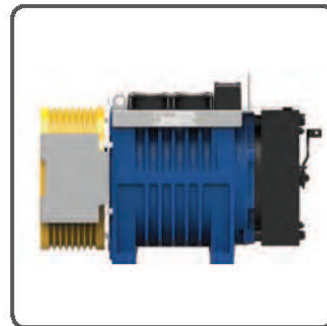

MONTERANI-MGV34 M



MONTERANI-MGV25S



Buttons Butonlar



ASB 2500-B9 ASB 7000-B2 ASB 5000-B1 ASB 7000-B1 ASB 6000-B1 ASB 4000-B6 ASB 1000-B1 ASB 2000-B3 ASB 2000-B1 ASB 6100-B4 ASB 800-B3



AVANTGARDE ASB 420D-S3 ASB 420D-S5 ASB 130-S1 ASB 130-S4 ASB 420 D-S2 ASB 420 Y-S3 ASB 425-MONŞARJ



ASB 415-MONŞARJ ASB 405-MONŞARJ ASB 400-MONŞARJ ASB 450-S1 ELEGANCE-S6 ASB 200-S3 ASB 200-S2 ASB 428-MONŞARJ



ASB - B2 ASB 600-S1 ASB 600-S2 ASB 300-S2

Vehicle Elevator

Araç Asansörü

Araç asansörleri, binaların üst ve bodrum katlarını otopark olarak kullanmaya olanak sağlamaktadır; yol, rampa gibi alan kayıplarını binaya geri kazandırmaktadır.

Vehicle elevators allow to use the upper and basement floors of the buildings as car parks; It restores area losses such as roads and ramps to the building.



ONAY KABİN®
ASANSÖR KABİNLERİ

ONAYLIFT[®]
COMPONENTS

Dumbwaiter Elevator

Servis Asansörü

Küçük tip yük asansörleri olarak düşünebileceğimiz Servis asansörleri 50 Kg'dan 250 Kg'a kadar değişik Taşıma kapasitelerine sahiptir.

Service elevators, which we can consider as small type freight elevators, have different carrying capacities from 50 Kg to 250 Kg.



Hospital & Freight Cabin

Hastane ve Yk Asansr

Hastanelerin gndelik alıřmaları gz nne alındıęında. Onaylift, hastane ulařım verimlilięini nemli lde iyileřtirmek iin verimli, gvenli ve gvenilir hastane ve yk asansrlerini zel olarak tasarlamaktadır.

Considering the daily work of hospitals. Onaylift is specially designing efficient, safe and reliable hospitals and freight elevators to significantly improve hospital transportation efficiency.



ONAY KABİN®
ASANSR KABİNLERİ

ONAYLIFT[®]
COMPONENTS



Panoramic Cabin

Panoramik Kabin

Onaylift Panoramic asansör serisi ürünleri estetiği, ileri teknolojiyi ve sanat konseptini birleştirir. Tasarımı ve performansı ile alışveriş merkezleri, otel ve turizm merkezlerinin yaygın kullanımı için tercih edilen dikey ulaşım çözümü olmaktadır.

Onaylift Panoramic lift series products combine aesthetics, advanced technology and art concept. With its design and performance, it is the preferred vertical transportation solution for the widespread use of shopping centers, hotels and tourism centers.



ONAY KABİN®
ASANSÖR KABINLARI

DETAYLAR

- 1,5 mm sac kabin duvarları
- 304 kalite paslanmaz çelik
- Hem iç hem dış paslanmaz kaplama
- Tamamı lazer kesimli parçalar
- Üç cepeye kadar cam seçeneği
- Farklı taban ve tavan seçenekleri
- Oval cam seçeneği
- Lamine cam koruma sertifikalı

DETAILS

- 1,5 mm sheet metal cabin wall
- 304 quality stainless steel
- Both internal and external stainless coating
- All parts are laser cut
- Glass options up to three sides
- Different floor and ceiling options
- Oval glass option
- Laminated glass -certification









Elevator Equipments

Asansör Ekipmanları

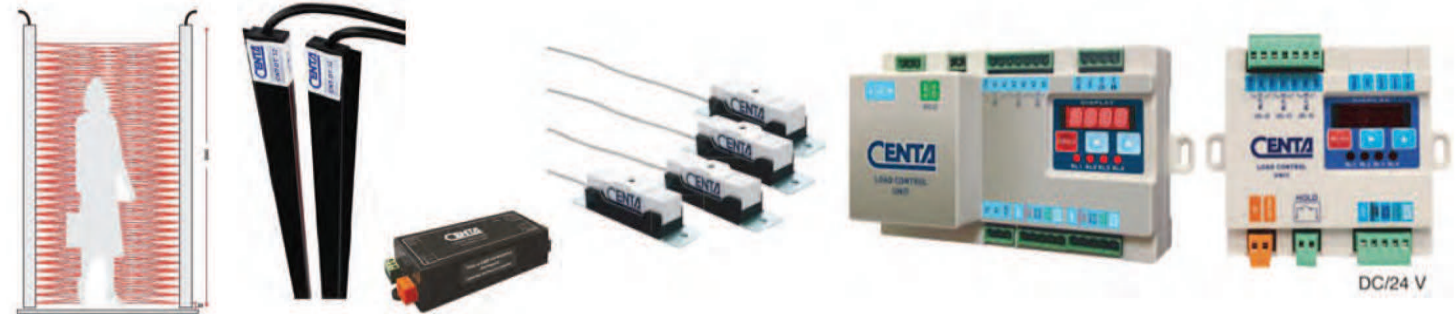
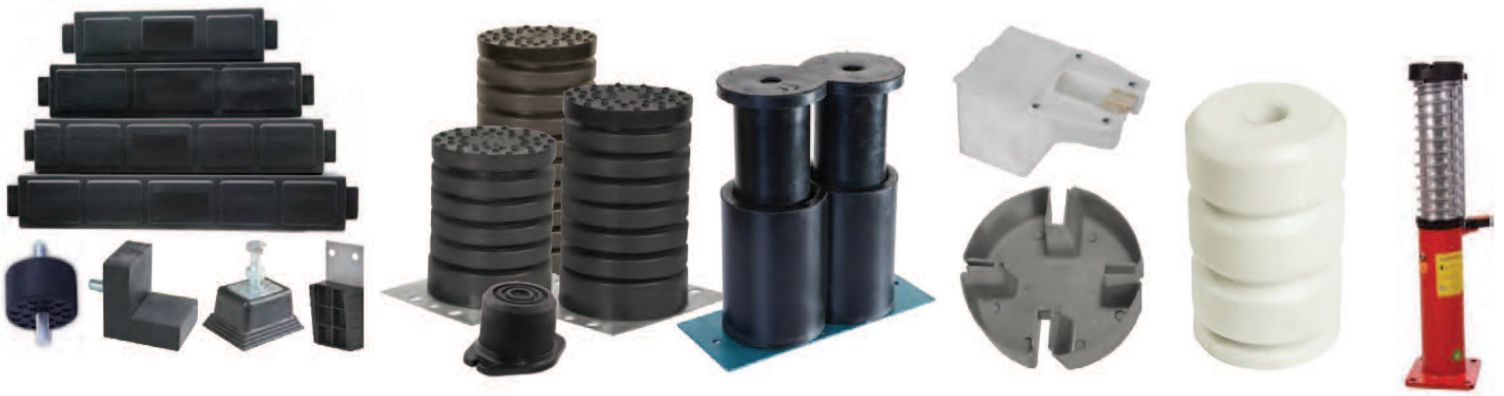

İnsan Asansörleri (Sınıf I-II) Fonksiyonel Boyutlar / Passenger Elevators (Class I-II) Functional Dimensions

				KONUTLAR / HOUSES				İŞYERLERİ / OFFICES					
TAŞIMA KAPASİTESİ / CAPACITY			(Kg)	320	400	630	1000	630	800	1000	1250	1600	
ANMA YÜKÜ / NOMINAL LOAD			(Kişi)	4	5	8	13	8	10	13	16	21	
KABİN ALANI / CABIN SPACE			(min)	0,79	0,98	1,45	2,15	1,45	1,73	2,15	2,57	3,245	
			(max)	0,95	1,17	1,66	2,40	1,66	2,00	2,40	2,90	3,56	
KABİN EBATLARI CABIN DIMENSIONS	Genişlik / Width	b1	(mm)	900	1100	1100	1100	1100	1350	1600	1950	1950	
	Derinlik / Depth	d1	(mm)	1000	1000	1400	2100	1400	1400	1400	1400	1750	
	Yükseklik / Height		(mm)	2200	2200	2200	2200	2200	2200	2300	2300	2300	
DURAK KAPILARI LANDING DOORS	Genişlik	b2	(mm)	700	800	800	800	800	800	1100	1100	1100	
	Yükseklik	h3	(mm)	2000	2000	2000	2000	2000	2000	2100	2100	2100	
KUYU EBATLARI SHAFT DIMENSIONS	Genişlik 1)	b3	(mm)	1400	1600	1600	1600						
	Genişlik 2)	b3	(mm)		1800	1800	1800	1800	1900	2400	2600	2600	
	Derinlik	d2	(mm)	1600	1600	1900	2600	2100	2300	2300	2300	2600	
KUYU DİBİ DERİNLİĞİ PIT	0,63m/sn	d3	(mm)	1400	1400	1400	1400	1400	1400	1400	1600	1600	
	1,00m/sn	d3	(mm)	1400	1400	1400	1400	1400	1400	1400	1600	1600	
	1,60m/sn	d3	(mm)		1600	1600	1600	1600	1600	1600	1600	1600	
	2,50m/sn	d3	(mm)			2200	2200		2200	2200	2200	2200	
EN ÜST DURAK SEVİYESİ ÜSTÜNDEKİ YÜKSEKLİK OVERHEAD	0,63m/sn	h1	(mm)	3600	3600	3600	3600	3800	3800	4200	4400	4400	
	1,00m/sn	h1	(mm)	3700	3700	3700	3700	3800	3800	4200	4400	4400	
	1,60m/sn	h1	(mm)	3800	3800	3800	3800	4000	4000	4200	4400	4400	
	2,50m/sn	h1	(mm)			5000	5000		5000	5200	5400	5400	
M A K İ N A H İ N D E A R O R E M S İ	ALAN SPACE	0,63m/sn	A	(m ²)	6	7,5	10	12	15	15	20	22	25
		1,00m/sn	A	(m ²)	6	7,5	10	12	15	15	20	22	25
		1,60m/sn	A	(m ²)		10	12	14	15	15	20	22	25
		2,50m/sn	A	(m ²)			14	16		18	20	22	25
	GENİŞLİK WIDTH	0,63m/sn	h1	(mm)	1600	2200	2200	2400	2500	2500	3200	3200	3200
		1,00m/sn	h1	(mm)	1600	2200	2200	2400	2500	2500	3200	3200	3200
		1,60m/sn	h1	(mm)		2200	2200	2400	2500	2500	3200	3200	3200
		2,50m/sn	h1	(mm)			2800	2800		2800	3200	3200	3200
	DERİNLİK DEPTH	0,63m/sn	d4	(mm)	3000	3200	3700	4200	3700	3700	4900	4900	5500
		1,00m/sn	d4	(mm)	3000	3200	3700	4200	3700	3700	4900	4900	5500
		1,60m/sn	d4	(mm)		3200	3700	4200	3700	3700	4900	4900	5500
		2,50m/sn	d4	(mm)			3700	4200		3700	4900	4900	5500
	YÜKSEKLİK HEIGHT	0,63m/sn	h2	(mm)	2000	2000	2000	2000	2200	2200	2400	2400	2800
		1,00m/sn	h2	(mm)	2000	2000	2000	2000	2200	2200	2400	2400	2800
		1,60m/sn	h2	(mm)		2200	2200	2200	2200	2200	2400	2400	2800
		2,50m/sn	h2	(mm)			2600	2600		2800	2800	2800	2800

*Sağa veya sola toplanan teleskopik kapılı asansörler için / For telescopic elevators with doors opening to the right and left

**Merkezden açılan kapılı asansörler için / For elevators with central opening

***320 ve 400 Kg. taşıma kapasiteli asansörler engelli kişilerin tekerlekli sandalyede asansörü kullanmaları için uygun değildir / Elevators with a load capacity of 320 and 420 kg are not suitable for use by people with disabilities in a wheelchair

Hasta Asansörleri (sınıf I-II) Fonksiyonel Boyutlar / Patient Lifts (class I-II) Functional Dimensions

TAŞIMA KAPASİTESİ / Capacity			(Kg)	1600	2000	2500
KABİN ALANI / Cabin space			(min)	3,245	3,82	4,625
			(max)	3,56	4,2	5
KABİN EBATLARI Cabinet Dimensions	Genişlik / Width	b1	(mm)	1400	1500	1800
	Derinlik / Depth	d1	(mm)	2400	2700	2700
	Yükseklik / Height		(mm)	2300	2300	2300
DURAK KAPILARI Stall Doors	Genişlik / Width	b2	(mm)	1300	1300	1300
	Yükseklik / Height	h3	(mm)	2100	2100	2100
KUYU EBATLARI Pit dimensions	Genişlik / Width	b3	(mm)	2400	2400	2700
	Derinlik / Depth	d2	(mm)	3000	3200	3300
KUYU DİBİ DERİNLİĞİ Elevator Pit Bottom	Vn=0,63m/sn	d3	(mm)	1600	1600	1800
	Vn=1,00m/sn	d3	(mm)	1700	1700	1900
	Vn=1,60m/sn	d3	(mm)	1900	1900	2100
	Vn=2,50m/sn	d3	(mm)	2500	2500	2500
EN ÜST DURAK SEVİYESİ ÜSTÜNDEKİ YÜKSEKLİK Height Above the Highest Stall Level	Vn=0,63m/sn	h1	(mm)	4400	4400	4400
	Vn=1,00m/sn	h1	(mm)	4400	4400	4600
	Vn=1,60m/sn	h1	(mm)	4400	4400	4600
	Vn=2,50m/sn	h1	(mm)	5400	5400	5600
MAKİNA DAİRESİ Engine Room	ALAN / Space	A	(m ²)	25	27	29
	GENİŞLİK / Width	b4	(mm)	3200	3200	3500
	DERİNLİK / Depth	d4	(mm)	5500	5800	5800
	YÜKSEKLİK / Height	h2	(mm)	2800	2800	2800

Yük Asansörleri (sınıf IV) Fonksiyonel Boyutlar / Load Elevators (Class IV) Functional Dimensions

TAŞIMA KAPASİTESİ / Carriage Quality			(Kg)	630	1000	1600	2000
KABİN EBATLARI Cabinet Dimensions	Genişlik / Width	b1	(mm)	1100	1300	1500	1500
	Derinlik / Depth	d1	(mm)	1400	1750	2250	2700
	Yükseklik / Height		(mm)	2200	2300	2200	2200
DURAK KAPILARI Stall Doors	Derinlik / Depth	b2	(mm)	1100	1300	1500	1500
	Yükseklik / Height	h3	(mm)	2100	2100	2100	2100
KUYU EBATLARI Pit Dimensions	Genişlik / Width	b3	(mm)	2100	2400	2700	2700
	Derinlik / Depth	d2	(mm)	1900	2300	2800	3200
KUYU DİBİ DERİNLİĞİ Elevator Pit Bottom	V<1,00m/sn	d3	(mm)	1500	1500	1700	1700
EN ÜST DURAK SEVİYESİ ÜSTÜNDEKİ YÜKSEKLİK Height Above the Highest Stall Level	V<1,00m/sn	h1	(mm)	4100	4100	4300	4300
MAKİNA DAİRESİ Engine Room	ALAN / Space	A	(mm)	12	14	18	20
	GENİŞLİK / Width	b4	(mm)	2800	3100	3400	3400
	DERİNLİK / Depth	d4	(mm)	3500	3800	4500	4900
	YÜKSEKLİK / Height	h2	(mm)	2200	2200	2400	2400

Servis Asansörleri (sınıf V) Fonksiyonel Boyutlar / Service Elevators (Class V) Functional Dimensions

TAŞIMA KAPASİTESİ / Carriage Quality			(Kg)	40	100	250
KABİN EBATLARI Cabinet Dimensions	Genişlik / Width	b1	(mm)	600	800	1000
	Derinlik / Depth	d1	(mm)	600	850	1000
	Yükseklik / Height		(mm)	800	800	1200
KUYU EBATLARI Pit Dimensions	Genişlik / Width	b3	(mm)	900	1100	1500
	Derinlik / Depth	d2	(mm)	800	1000	1200

ASANSÖRE DAİR ARADIĞINIZ, HER ŞEY...

EVERYTHING YOU ARE
LOOKING FOR ABOUT ELEVATORS...

ONAYLIFT[®]
COMPONENTS

Fabrika:

5. Organize San. Bölğ. Aşağıpınarbaşı OSB Mah.
522. Sokak No:5 Selçuklu / Konya / TÜRKİYE
Tel: +90 332 346 21 24 | Fax: +90 332 346 21 25
info@onaylift.com.tr | www.onaylift.com.tr

Şube:

Beylikdüzü O S B Mahallesi Birlik Sanayi Sitesi
4. Cadde No:26 Beylikdüzü / İstanbul / TÜRKİYE
Tel: +90 212 876 11 35 Fax: +90 212 876 11 36
bilgi@onaylift.com.tr | www.onaylift.com.tr

MÜŞTERİ HİZMETLERİ
Customer Service
444 32 42

ONAY DOOR
KAPI SİSTEMLERİ

ONAY KABİN
ASANSÖR KABİNLERİ

ONAY KUMANDA
KUMANDA SİSTEMLERİ